

RCA

USER'S GUIDE

multimediamonitormultimedia
monitormultimediamonitormul
timediamonitormultimediamon
itormultimediamonitormultim
ediamonitormultimediamonito
rmultimediamonitormultimedi
amonitormultimediamonitormu
ltimediamonitormultimediamo
nitormultimediamonitormulti
mediamonitormultimediamonit
ormultimediamonitormultimed
iamonitormultimediamonitorm
ultimediamonitormultimediam
onitormultimediamonitormult
imediamonitormultimediamoni
tormultimediamonitormultime
diamonitormultimediamonitor
multimediamonitormultimedia
monitormultimediamonitormul
timediamonitormultimediamon
itormultimediamonitormultim
ediamonitormultimediamonito
rmultimediamonitormultimedi
amonitormultimediamonitormu
ltimediamonitormultimediamo
nitormul timedia
moni tormulti
med iamonit
orm ult
imedi a
monit or
multi me
diam on
ito r



GUIDE *plus*[™]
GOLD
GENERAL

IMPORTANT INFORMATION

WARNING

To reduce the risk of fire or electric shock, do not expose this product to rain or moisture.

WARNING

RISK OF ELECTRIC SHOCK DO NOT OPEN

To reduce the risk of electric shock, do not remove cover (or back). No user-serviceable parts inside. Refer servicing to qualified service personnel.



This symbol indicates "dangerous voltage" inside the product that presents a risk of electric shock or personal injury.



This symbol indicates important instructions accompanying the product.

Refer to the identification/rating label located on the back panel of your product for its proper operating voltage.

FCC Regulations state that unauthorized changes or modifications to this equipment may void the user's authority to operate it.

If fixed (non-moving) images are left on the screen for long periods, they may be permanently imprinted on the screen. Such images include network logos, phone numbers, and video games. This damage is not covered by your warranty. Extended viewing of channels displaying these images should be avoided.

Cable TV Installer: This reminder is provided to call your attention to Article 820-40 of the National Electrical Code (Section 54 of the Canadian Electrical Code, Part 1) which provides guidelines for proper grounding and, in particular, specifies that the cable ground shall be connected to the grounding system of the building as close to the point of cable entry as practical.

PRODUCT REGISTRATION

Please fill out the product registration card and return it immediately. Returning the card allows us to contact you if needed.

Keep your sales receipt to obtain warranty parts and service and for proof of purchase. Attach it here and record the serial and model numbers in case you need them. The numbers are located on the back of the product.

Model No. _____

Serial No. _____

Purchase Date: _____

Dealer/Address/Phone: _____

G-LINK, VCR Plus+, C³, PlusCode, GUIDE Plus+, and GUIDE Plus+ Gold are trademarks of Gemstar Development Corporation.

The GUIDE Plus+ Gold system is manufactured under license from Index Systems Inc.

Thomson Consumer Electronics and Gemstar are not in any way liable for the accuracy of the program information provided by the GUIDE Plus+ System. In no event shall Thomson Consumer Electronics or Gemstar be liable for any amount representing loss of profits, loss of business, or indirect, special, or consequential damages in connection with the provision or use of any information equipment, or services relating to the GUIDE Plus+ System.

TABLE OF CONTENTS

MAKING CONNECTIONS	3
Connecting Components to your Monitor	4
Antenna/Cable In	4
Audio/Video/S-Video Inputs (Input1, Input2, Input3)	5
Audio/Component Video Inputs	6
Selected Audio/Video Outputs	6
Audio Output	7
Optional Component Connection Examples	8
(S)VGA Video Inputs –(S)VGA1, (S)VGA2	12
USB Inputs/Output	15
Connecting the G-LINK Cable	15
How to Find the Remote Control Sensor	15
Placing the Wands Under the VCR and/or Cable Box	16
Front Inputs	16
SETTING UP	17
Step 1: Plug In The Monitor	18
Step 2: Place batteries in remote	18
Step 3: Turn on the Monitor	18
The Point and Select Navigation Method	18
Step 4: Set Up the GUIDE Plus+ Gold System	18
Step 5: Run Auto Channel Search	20
USING THE REMOTE	21
Remote Buttons	22
Using the WHO•INPUT button	23
Programming the Remote	23
Testing the Remote	24
Programming the Remote	24
Using the Remote to Control a Device	25
Modes of Operation	25
Front Panel	25
MENUS AND FEATURES	27
Audio Menu	28
Picture Quality Menu	29
Screen Menu	30
Channel Menu	31
Set Time Menu	32

TABLE OF CONTENTS

Parental Controls and V-Chip	33
V-Chip TV Rating Limit	34
V-Chip Movie Rating Limit	38
V-Chip Unrated Program Block	39
Channel Block	39
Front Panel Block	39
Lock/Unlock Parental Controls	39
PIP (Picture-in-Picture) Operation	40
PIP Buttons	40
Using the PIP Feature	40
PIP Problems?	41
Using the Autotuning Feature	41
Set the VCR1 Channel	42
Set the VCR2 Channel	42
Set the DVD Channel	42
Set the SAT/CABLE Channel	42
Channel Banner	43
GUIDE Plus+ Gold Menu	44
About the GUIDE Plus+ Gold System	44
Downloading Data	45
Grid Guid	46
Sort	47
News	48
Schedule	48
Messages	49
Editor	49
Setup	50
Expanded Information	50
REFERENCE.....	51
MultiMedia Monitor Specifications*	52
Troubleshooting	53
Care and Cleaning	55
Radio Interference	56
RCA MultiMedia Monitor Limited Warranty	59

MAKING CONNECTIONS

GETTING STARTED

This manual is designed to get you started quickly. The first three sections of the manual show you how to:

- Connect your monitor to other devices
- Set up your monitor
- Program the remote

The remaining sections discuss the menus and features, and include a Reference section which contains troubleshooting tips, care and cleaning instructions, accessory ordering information and your warranty.

1 MAKING CONNECTIONS



2 SETTING UP



3 USING THE REMOTE



4 MENUS AND FEATURES



5 REFERENCE

Check out the notes that have been added throughout the manual in these tip boxes. There are some important tips that will help you get the most from your monitor.

MAKING CONNECTIONS

CONNECTING COMPONENTS TO YOUR MONITOR

Your monitor has several input and output jacks that you can use with many different types of components. This creates a great number of connection variations. Therefore, the following section shows the different types of jacks and examples of the types of components that can be connected to those jacks. Before you begin, it's a good idea to read any connection information in other components' user manuals as well.

Before You Connect

Protect against power surges:

- Connect all components before plugging any power cords into the wall outlet.
- Turn off the monitor and/or component before connecting or disconnecting any cables.
- Make sure all antennas and cables are properly grounded. Refer to the "Important Safeguards" sheet packed with your monitor.

ANTENNA/CABLE IN

The ANTENNA/CABLE IN jack lets you connect a screw-on or push-on antenna or cable lead. Use this if you want the monitor to receive signals through a coaxial cable from an antenna or other source, such as a VCR.

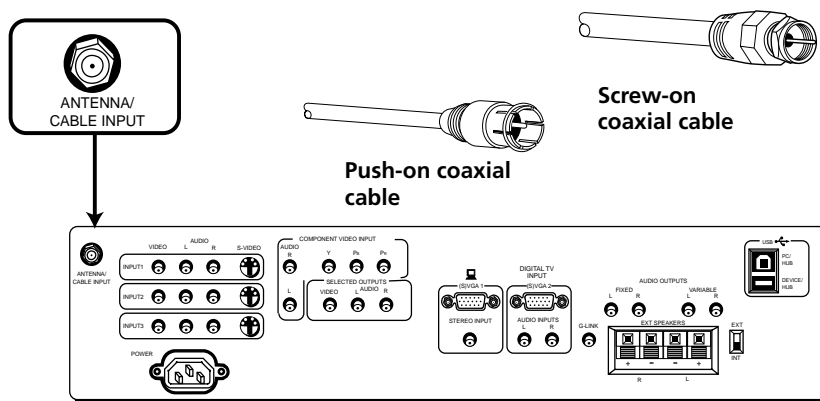

You can use coaxial cables to connect devices such as:

- Antenna or cable leads
- Cable boxes
- VCRs
- Satellite receivers

MAKING CONNECTIONS

AUDIO/VIDEO/S-VIDEO INPUTS (INPUT1, INPUT2, INPUT3)

The audio jacks provide stereo sound. If your device has only one audio output, you need to connect a "Y" adapter to your component and to both the left and right inputs on the monitor.

The video jack provides better picture quality than coaxial cable, because it carries only video signals.

If your device has S-Video output, use an S-Video cable to connect the video jacks. This method separates the video signals into two separate signals: one for color, the other for brightness. This helps prevent the signal from degrading and results in a sharper image.

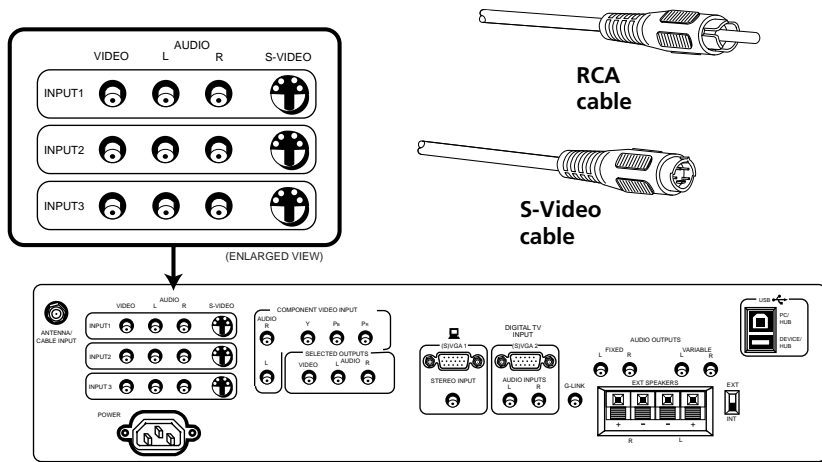

You can use audio/video and S-Video jacks to connect devices such as:

- VCRs
- Satellite receivers
- DVD players
- Laserdisc players
- Camcorders
- Internet devices

To View the Video Inputs...

First, press the TV button on the remote to make sure that the remote is in TV mode; then press the WHO•INPUT button each time you want to move to the next video input channel.

MAKING CONNECTIONS

SELECTED AUDIO/VIDEO OUTPUTS

Provides audio and video output from the last selected source (except component and SVGA jacks).

VIDEO provides video output. It gives better picture quality than just a coaxial cable because it carries only video signals.

AUDIO L and R provide stereo sound. They give better audio quality than just an RF coaxial cable because they carry only audio signals.

In PC Mode...

In PC mode, the last selected source (for the selected output) appears. The source is what you were watching on INPUT 1, 2, 3, FRONT, or the tuner channel.

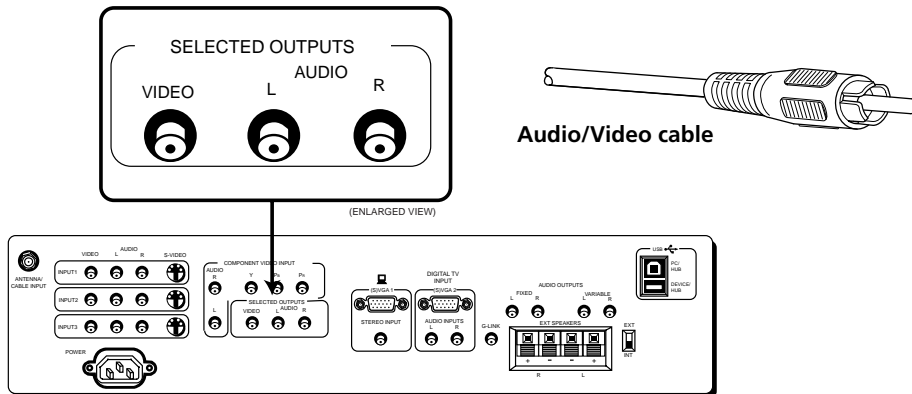

You can use audio/video jacks to connect devices such as:

- compatible A/V receivers
- compatible recording equipment
- PCs with a compatible graphics card

AUDIO/COMPONENT VIDEO INPUTS

These jacks let you connect a compatible component video source, such as a DVD player or digital TV converter box. Unlike a single video input, component video maintains the video signal as three separate signals. The component video connection provides optimum quality. The audio jacks provide stereo sound. **It is essential to match the color coded connectors between a compatible device and the monitor.**

Component Video Tip

To ensure maximum picture quality, use three video-grade cables for the Y, Pb, and Pr connections.

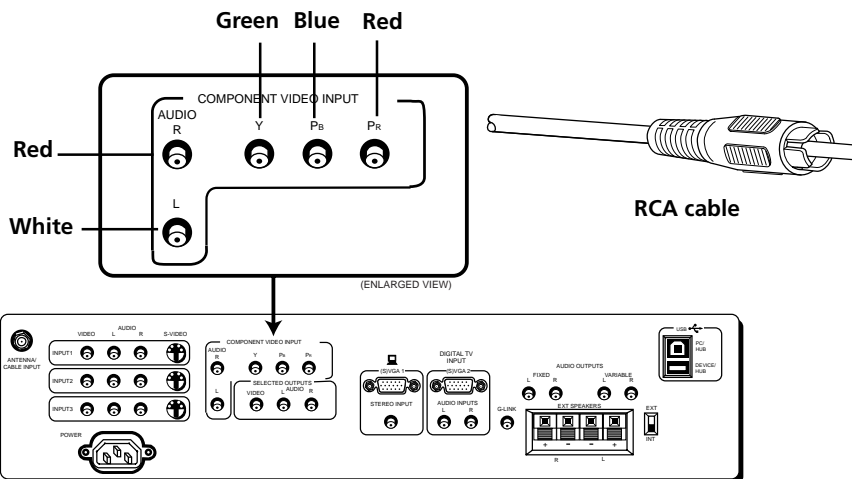

To View the Component Video Input...

First, press the TV button on the remote to make sure that the remote is in TV mode; then press the WHO•INPUT button to scroll through the video input channels until you get to the COMP input channel.

MAKING CONNECTIONS

AUDIO OUTPUT

FIXED provides fixed-level audio output from the monitor. This audio output is ideal for connecting to an A/V receiver when you want to control the volume through the A/V receiver.

VARIABLE provides variable-level audio output. Volume levels are controlled by the volume controls on the monitor and monitor remote control.

EXT SPEAKERS lets you connect external left and right speakers to the monitor. The EXT/INT switch beside the jacks let you turn the monitor's internal speakers on or off. EXT sends audio to external speakers. INT sends audio only to the monitor's internal speakers.

Audio Output Tips

- You may want to adjust the monitor's tone control and audio processor settings to enhance the audio output when connecting an A/V receiver to the Variable output jacks.
- You can turn off the monitor's internal speakers by using the "Speakers" control in the Audio menu. (See the "Audio Menu" section for more information.)

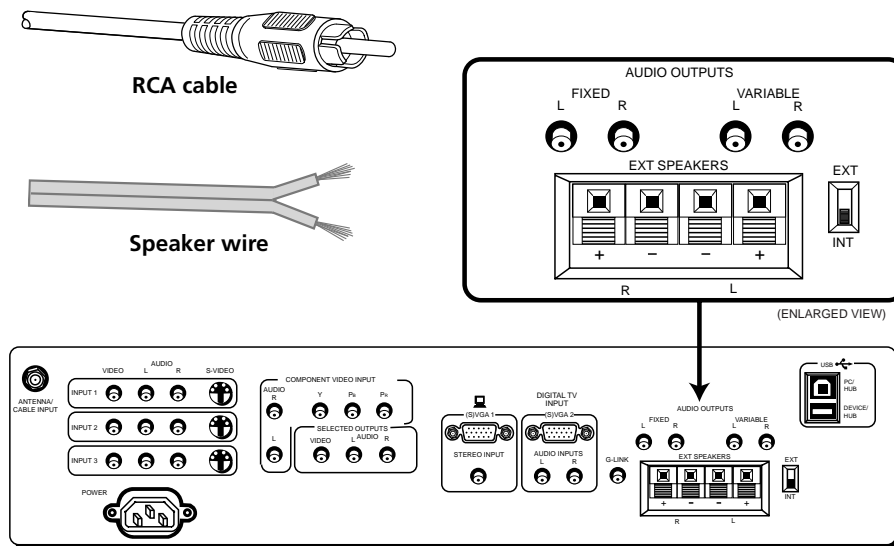

You can use audio output jacks to connect devices such as:

- Audio/video receiver
- Audio amplifier
- Optional external speakers

External Speaker Rating

The external speaker rating is 8 ohms with 10 watts power handling capabilities.

MAKING CONNECTIONS

OPTIONAL COMPONENT CONNECTION

EXAMPLES

The following examples feature some of the optional components you can connect to your monitor. Refer to the preceding pages for the types of cables used for each connection.

Monitor and a VCR

1. Connect the coaxial cable carrying your television signal (off air or cable) to the antenna input on the VCR.
2. Connect a coaxial cable to the VCR's antenna output and to the ANTENNA/CABLE INPUT jack on the monitor.
3. Use RCA cables to connect the VCR's audio/video output to INPUT1 on the monitor.

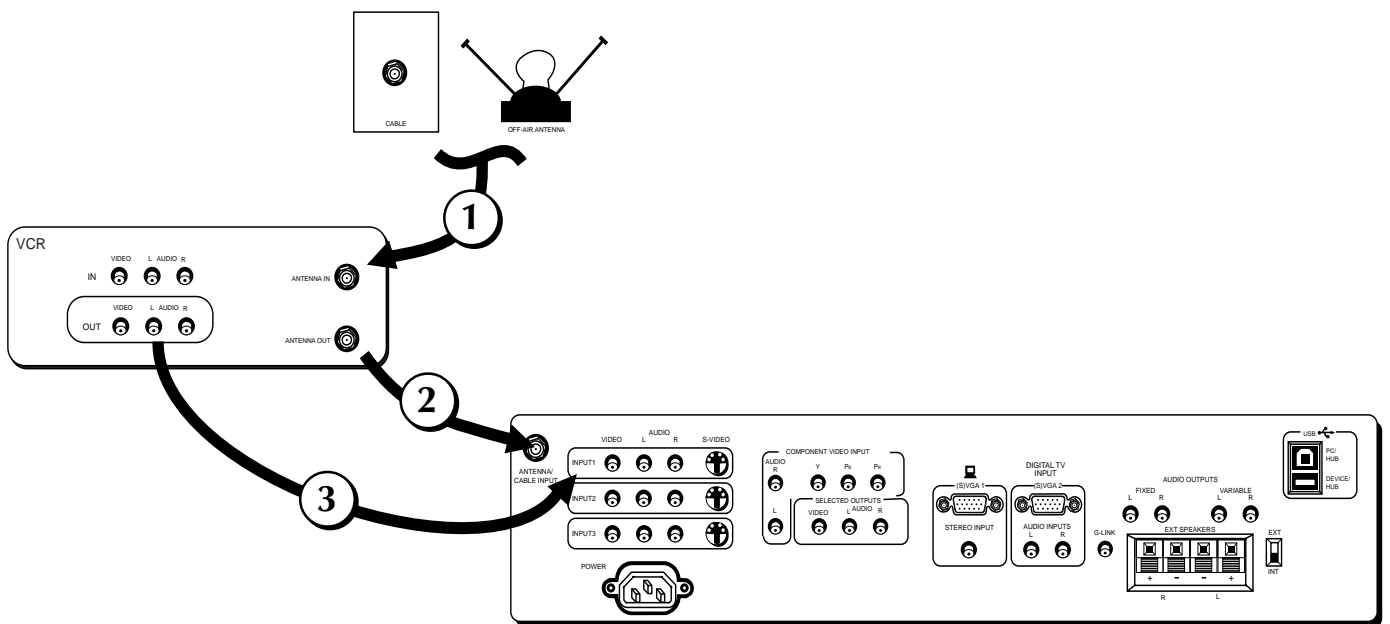

Viewing the VCR Input Channel

1. Turn on the monitor and the VCR.
2. Press the TV button on the remote control.
3. Press WHO•INPUT on the remote to scroll through the video inputs.

Direct Channel Tuning

You can set up the monitor to automatically tune to the VCR input. This is called Autotuning. (See "Menus and Features" for more information.)

MAKING CONNECTIONS

Monitor, VCR, and a Satellite Receiver

1. Connect the coaxial cable carrying your television signal (off air or cable) to the antenna input on the VCR.
2. Connect a coaxial cable to the VCR's antenna output and to the ANTENNA/CABLE INPUT jack on the monitor.
3. Use RCA cables to connect the VCR's audio/video output INPUT1 on the monitor.
4. Use RCA cables to connect the satellite receiver's audio/video output to INPUT2 on the monitor. If your satellite receiver has an S-Video output, you can make the video connection by using the S-Video jacks instead.

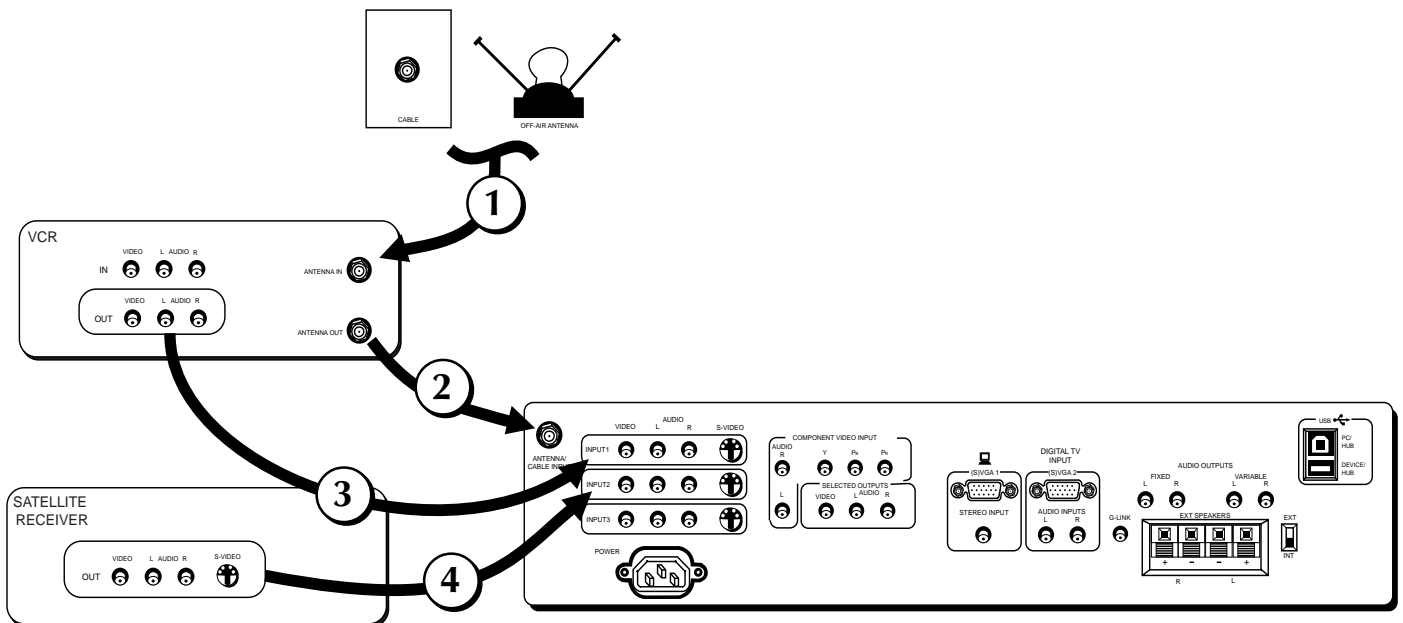

Viewing the Components

1. Turn on the monitor and the component(s) you want to view.
2. Press the TV button on the remote control.
3. Press the WHO•INPUT button on the remote control to scroll through the video inputs.
 - The VCR can be viewed on the VID1 input channel.
 - The satellite receiver can be viewed on the VID2 input channel.

Direct Channel Tuning

You can set up the monitor to automatically tune to the correct input channel. This is called Autotuning. (See "Menus and Features" for more information.)

MAKING CONNECTIONS

Monitor, VCR, Satellite Receiver, and a DVD Player

1. Connect the coaxial cable carrying your television signal (off air or cable) to the antenna input on the VCR.
2. Connect a coaxial cable to the VCR's antenna output and to the ANTENNA/CABLE INPUT jack on the monitor.
3. Use RCA cables to connect the VCR's audio/video output to INPUT1 on the monitor.
4. Use RCA cables to connect the satellite receiver's audio/video output to INPUT2 on the monitor. If your satellite receiver has an S-Video output, you can make the video connection by using the S-Video jacks instead.
5. Use RCA cables to connect the DVD player's audio/video output to INPUT3 on the monitor. If your DVD player has an S-Video output, you can make the video connection by using the S-Video jacks instead.

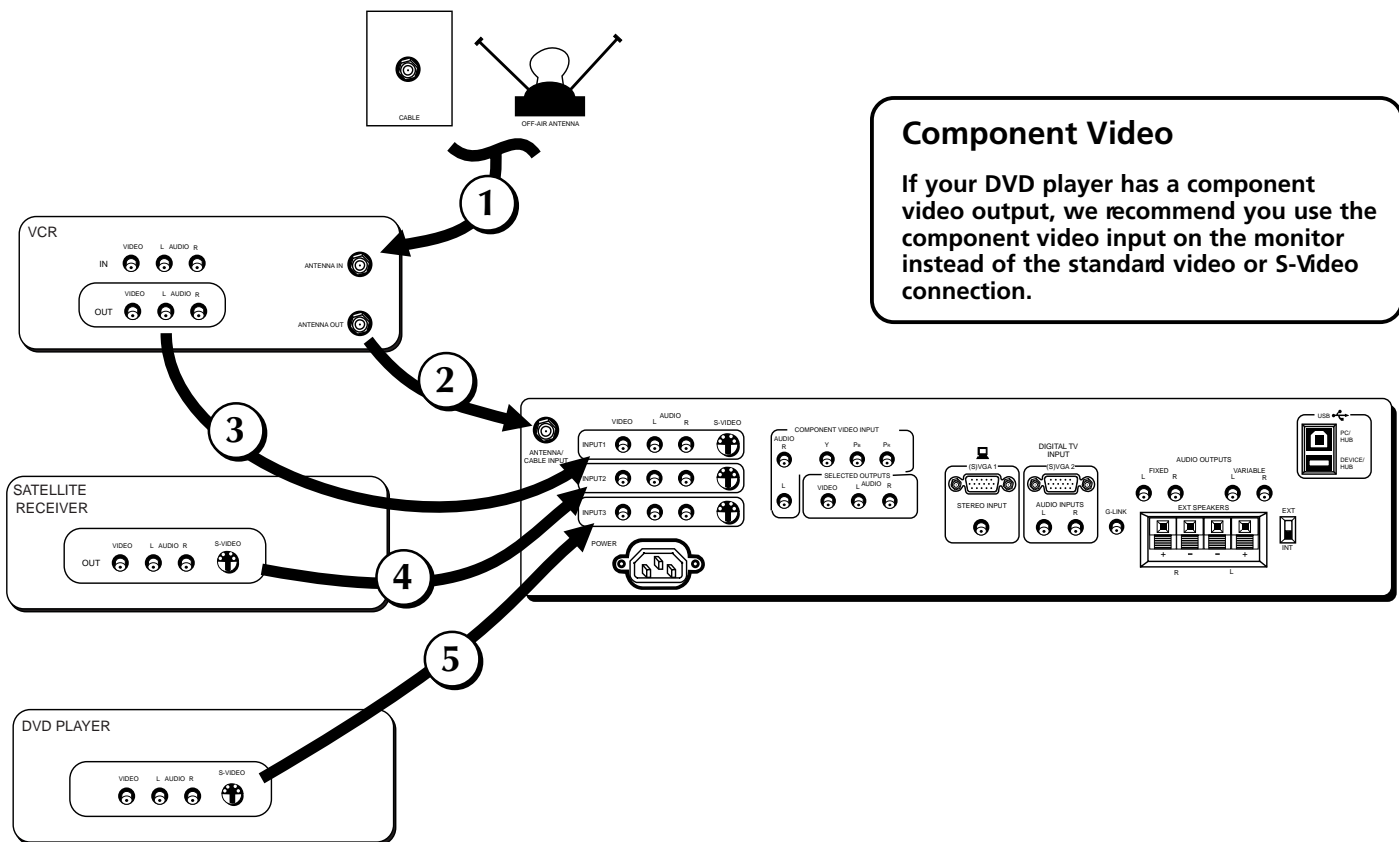

Viewing the Components

1. Turn on the monitor and the component(s) you want to view.
2. Press the TV button on the remote control.
3. Press the WHO•INPUT button on the remote control to scroll through the video inputs.
 - The VCR can be viewed on the VID1 input channel.
 - The satellite receiver can be viewed on the VID2 input channel.
 - The DVD player can be viewed on the VID3 input channel.

Direct Channel Tuning

You can set up the monitor to automatically tune to the correct input channel. This is called Autotuning. (See "Menus and Features" for more information.)

MAKING CONNECTIONS

A/V Receiver & Speakers

1. Use RCA cables to connect either the **FIXED** or **VARIABLE AUDIO OUTPUT** from the monitor to an A/V receiver.
 - **FIXED** provides fixed-level audio output from the monitor. This audio output is ideal for connecting to an A/V receiver that has its own volume control.
 - **VARIABLE** provides variable-level audio output. Volume levels are controlled by the volume controls on the monitor and monitor remote control.
2. Use speaker wire to connect the monitor to external speakers.
 - The **EXT/INT** switch beside the jacks let you turn the monitor's internal speakers on or off. **EXT** sends audio to external and internal speakers. **INT** sends audio only to the monitor's internal speakers.

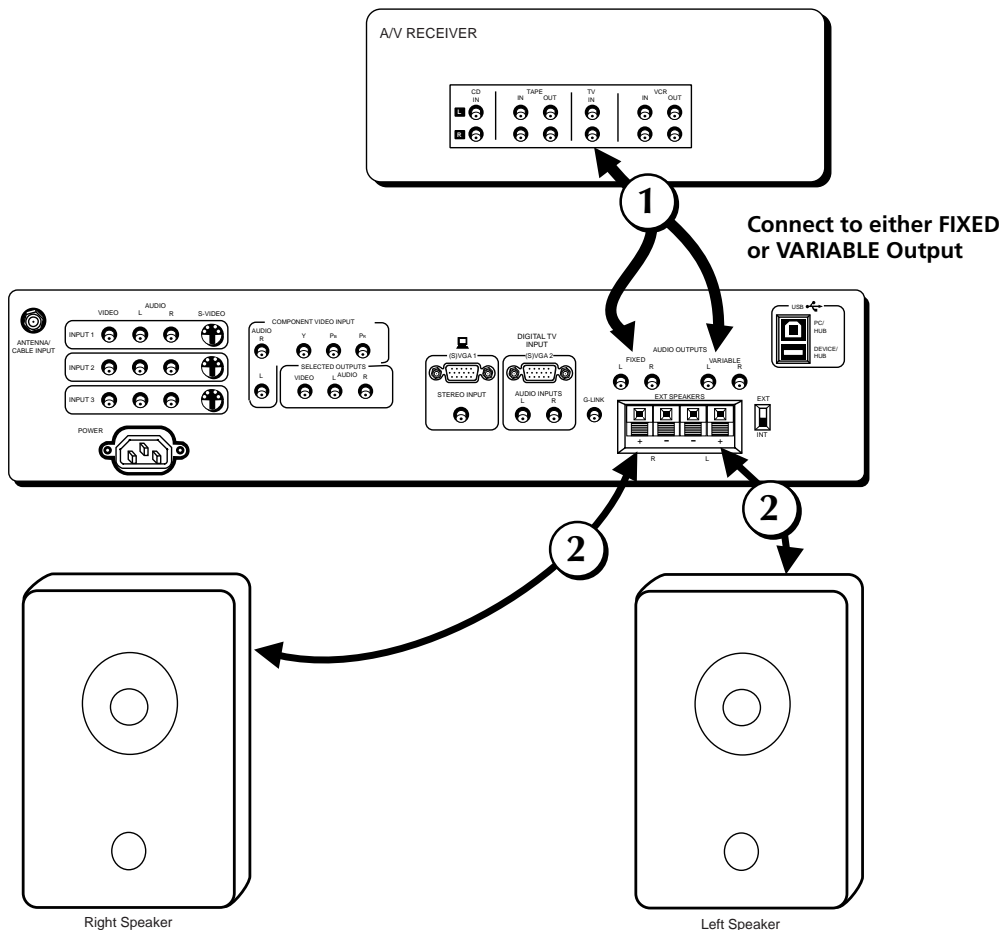

MAKING CONNECTIONS

(S)VGA VIDEO INPUTS –(S)VGA1, (S)VGA2

The (S)VGA (Super Video Graphics Adapter) inputs let you connect your monitor to a personal computer and internet devices. These inputs can provide up to 800 pixel x 600 pixel resolution. How images are displayed, however, depends on other factors such as the type of device connected to the monitor, the media being transmitted, graphics cards and memory allotments.

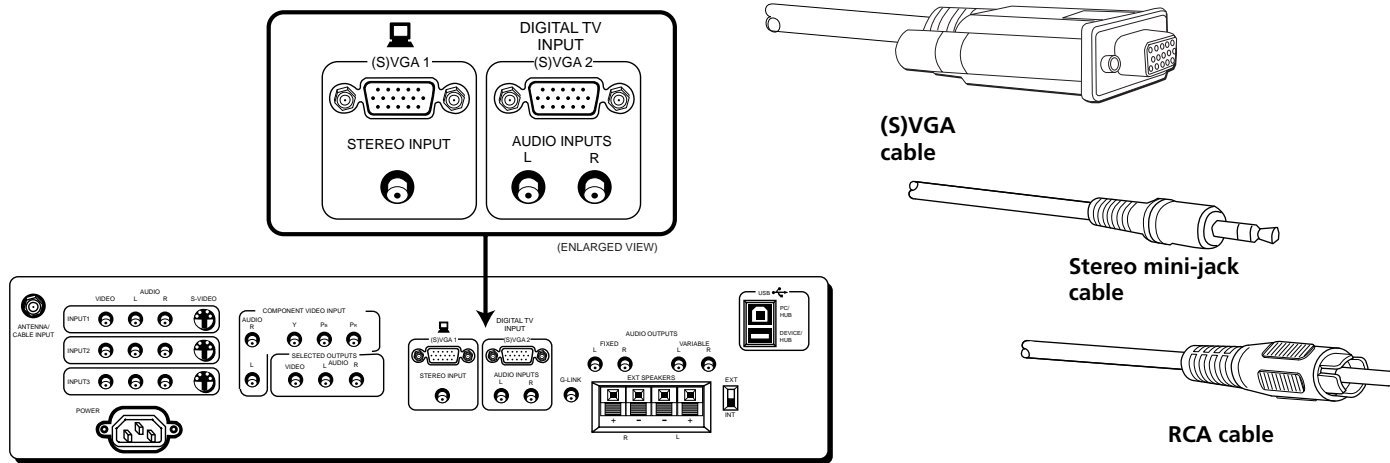

Scan Rates

The computer scan rates supported are:

- VGA 640x480, 60Hz progressive
- (S)VGA 800x600, 60Hz progressive

Make sure that you appropriately adjust the display properties for your computer.

You can change the picture mode settings for the (S)VGA inputs by using the *Picture Mode* menu. To access the *Picture Mode* menu, press TV and then MENU on the remote. Select *Picture Quality*, then *Picture Mode*.

Computer/Text is the recommended input and setting for most PC connections when viewing text and graphics. Text may appear crisper in Text mode.

Video is the default setting for the (S)VGA2 input. This input and setting is recommended for high definition television (HDTV) converter connections. Also, computer games may appear better in Video mode. The appearance of text in Video mode may be improved by decreasing the picture's sharpness and contrast (see the section "Menus and Features" for details).

Picture Mode menu

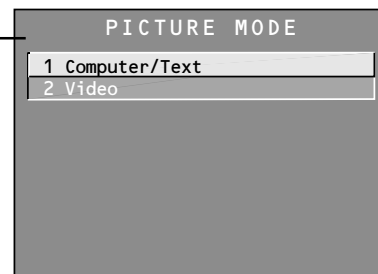

MAKING CONNECTIONS

(S)VGA1 Input Connection Examples

1. Connect the supplied (S)VGA cable to your computer and to the monitor.
 2. Connect the audio:
 - Connect the stereo mini-jack cable to the computer and to the STEREO INPUT jack on the monitor.
- OR
- Connect the RCA-type connectors of a “Y” adapter to the audio outputs on the computer, and connect the stereo mini-jack connector to the STEREO INPUT jack on the monitor.

The (S)VGA1 input supports DDC2B and VESA DPMS when using an appropriate cable. We recommend using the VGA cable supplied with this monitor.

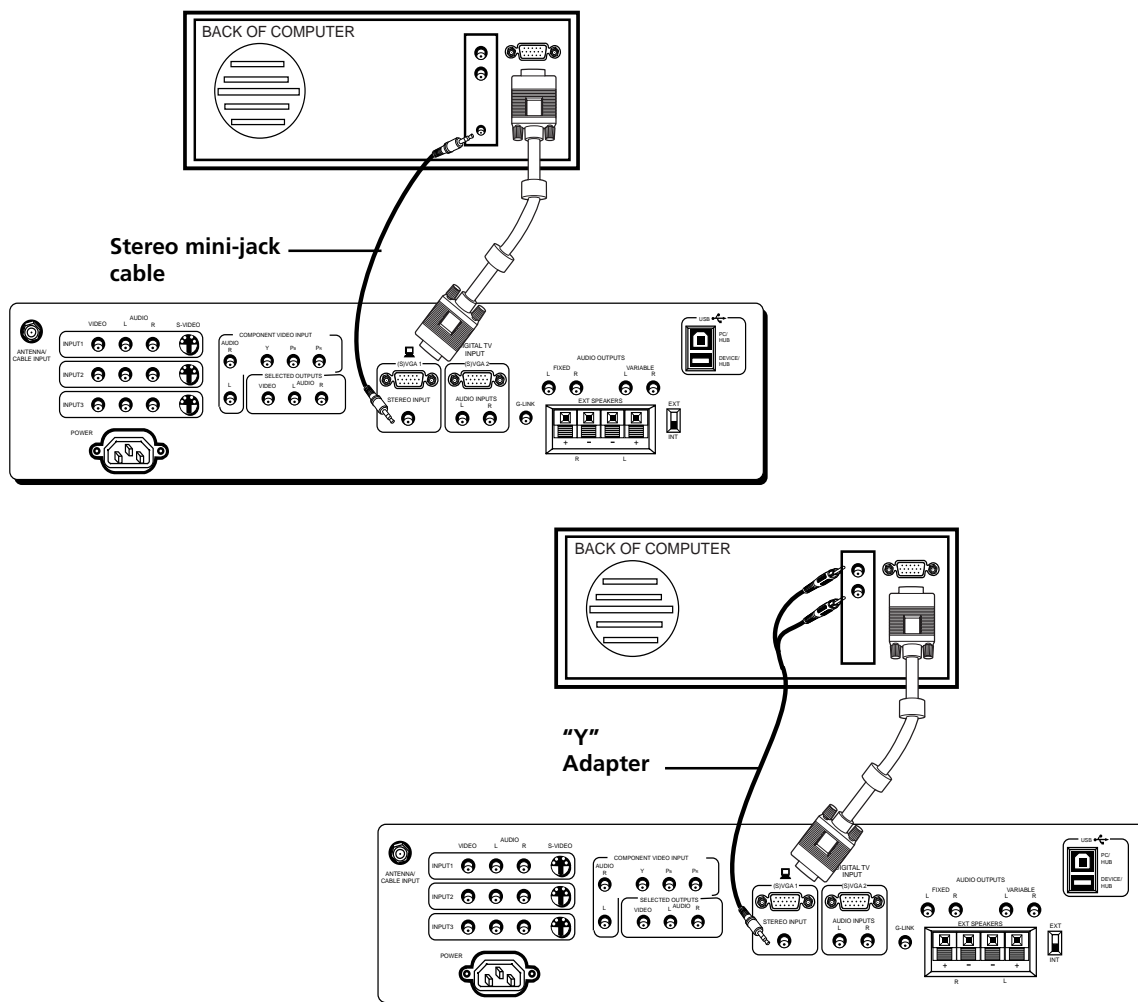

Viewing the (S)VGA1 Input

1. Turn on the monitor and the computer.
2. Press the TV button on the remote control.
3. Press the WHO•INPUT button on the remote control to scroll through the video inputs until you get to the VGA1 input.

(If you have difficulty getting your screen to appear on the monitor, see the *Troubleshooting* section of this manual for possible solutions.)

MAKING CONNECTIONS

(S)VGA2 Input

The (S)VGA2 input can be used to connect an HD receiver so you can receive high definition signals.

1. Connect the supplied (S)VGA cable to your HD receiver and to the monitor. Due to copyright restrictions, you may not be able to view some high definition programs in high definition format using this product. To view material in standard definition instead, you must connect the Audio/Video jacks to the monitor.
2. Connect an RCA-type cable from the HD receiver's audio Right, Left, and video jacks to the audio in's Right, Left, and video jacks on the monitor.
3. Connect an Audio cable from the HD receiver's audio right and left jacks to the monitor's VGA left and right audio inputs.
4. Connect an optional S-Video cable from the HD receiver's S-Video jack to the monitor's S-Video jack.

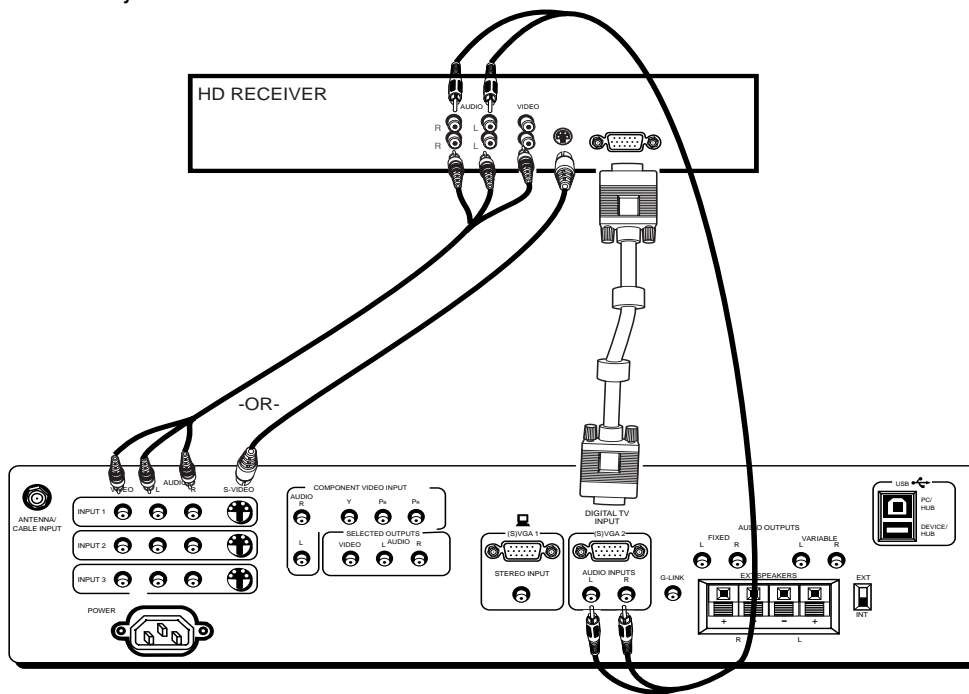

Viewing the (S)VGA2 Input

1. Turn on the monitor and the HD receiver.
2. Press the TV button on the remote control.
3. Press the WHO•INPUT button on the remote control to scroll through the video inputs until you get to the VGA2 input.

If your RCA or PROSCAN HD receiver switches from a high definition output to a standard definition output, the monitor will automatically switch from the high definition (S)VGA2 input channel to the standard definition INPUT2 (VID2) channel in order for you to view the signal. There are two situations in which this would occur:

- When recording from the HD receiver.
- When a high definition output signal is not allowed by the program provider and/or movie studio for that particular program.

Direct Channel Tuning

You can set up the monitor to automatically tune to the (S)VGA2 input when you press the SAT•CABLE button on the remote. This is called Autotuning. (See "Menus and Features" for more information.)

MAKING CONNECTIONS

USB INPUTS/OUTPUT

USB (Universal Serial Bus) inputs let you connect PC-type peripheral devices to the monitor. This includes devices such as joysticks, keyboards, and pointing devices (mouse, trackball). There are three USB inputs and one USB output that connects to a PC. The monitor acts as a hub to the PC.

NOTE

The USB port will function even when the monitor is in standby (off, but plugged in) mode.

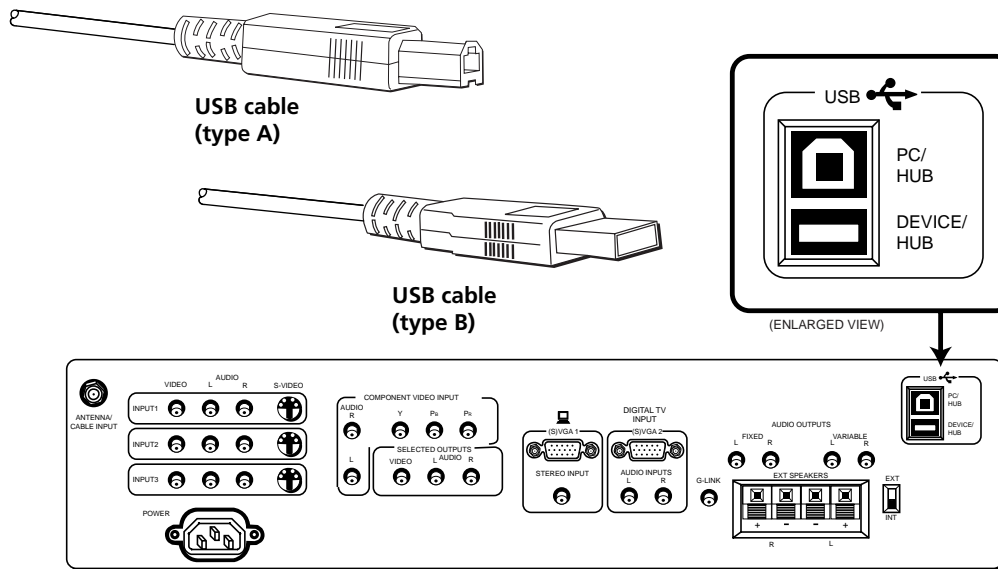

CONNECTING THE G-LINK CABLE

The G-LINK cable enables the GUIDE Plus+ Gold System (the on-screen guide that lists what shows are on TV) to work with your VCR and/or cable box. If there is a demo pin in the G-LINK jack, you must remove it before you connect the G-LINK cable. If there is no demo pin, just insert the G-LINK cable into the G-LINK jack.

Cable Box – If your TV is connected to a cable box and you don't connect the G-LINK cable, no channels will be listed in the on-screen program guide.

VCR – If your monitor is connected to a VCR and you don't connect the G-LINK cable, one-touch recording won't work. The other features of the guide will work properly.

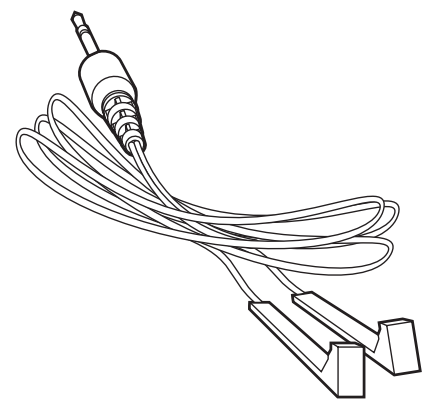

HOW TO FIND THE REMOTE CONTROL SENSOR

You have to place the wands on the G-LINK cable in front of the remote control sensor on the VCR and/or cable box. Some cable boxes and VCRs have the remote control sensor labeled on the unit. If the remote sensor isn't labeled on your VCR and/or cable box, you need to use the remote control that came with the VCR and/or cable box to locate the sensor.

1. Turn off the VCR and/or cable box.
2. Hold the remote control (**not** the one that came with your TV, but the one that came with the cable box and/or VCR) so it is touching the front of the component.

The G-LINK cable is used to send commands to your VCR and/or cable box.

If there is a demo pin in the G-LINK jack, you must remove it before you connect the G-LINK cable. If there is no demo pin, just insert the G-LINK cable into the G-LINK jack.

MAKING CONNECTIONS

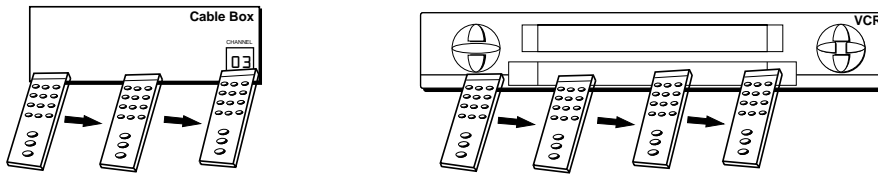

3. Slowly move the remote control across the front of the component (VCR or cable box) while you press the power button on and off. You must press and release the power button each time you move the remote (holding down the button won't work).
4. When the component turns on, you've located the sensor.
5. Place the wands of the G-LINK cable underneath your VCR and/or cable box (see instructions below).

PLACING THE WANDS UNDER THE VCR AND/OR CABLE BOX

Place the wands of the G-LINK cable underneath your VCR and/or cable box. Place them about one inch away from the remote control sensor.

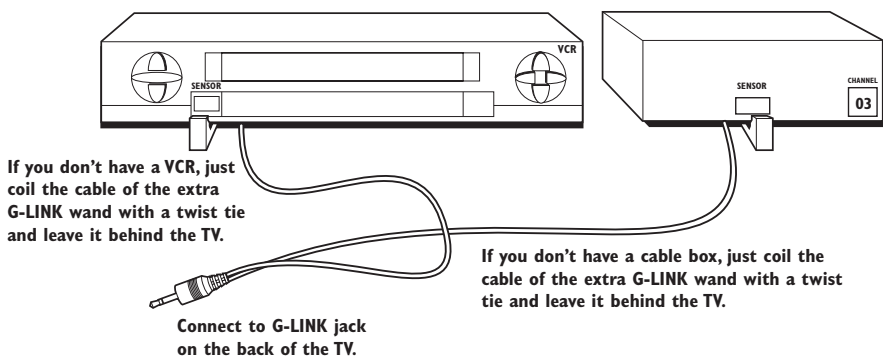

If you don't have a VCR, just coil the cable of the extra G-LINK wand with a twist tie and leave it behind the TV.

If you don't have a cable box, just coil the cable of the extra G-LINK wand with a twist tie and leave it behind the TV.

Connect to G-LINK jack on the back of the TV.

FRONT INPUTS

The monitor has front inputs for convenience; one set of audio/video (A/V) inputs, a headphone jack and two client USB ports. Look for a hinged door and gently lift the cover open. Please note that the illustration below shows a typical front input layout. The exact look of the jacks or monitor pictured here may be different than yours.

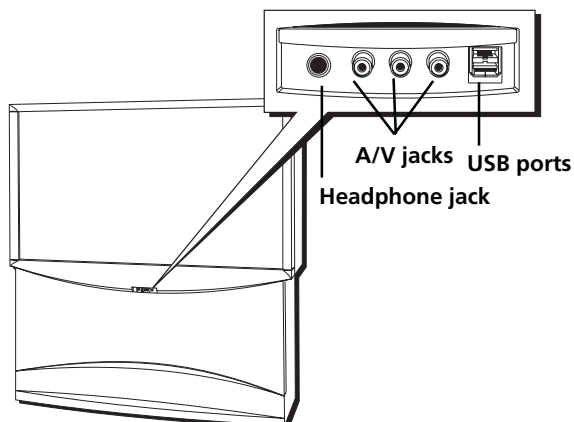

NOTE

When you plug in headphones, the monitor's internal and external speakers are automatically turned off.

When connecting a device that uses a monaural cable, such as some camcorders, use the left input jack to get sound from both speakers.

SETTING UP

SET UP THE MONITOR

This section guides you through the first time you use your monitor and show you how to:

- Conduct an Auto Channel Search
- Set up the GUIDE Plus+ Gold System
- Set the time (if necessary)
- Program the TV to tune to a certain channel when a certain device button on the remote is pressed
- Label the channels

1 MAKING CONNECTIONS



2 SETTING UP



3 USING THE REMOTE



4 MENUS AND FEATURES



5 REFERENCE

Check out the notes that have been added throughout the manual in these tip boxes. There are some important tips that will help you get the most from your monitor.

SETTING UP

STEP 1: PLUG IN THE MONITOR

Plug the end of the power cord into an appropriate wall outlet. Be sure to insert the plug completely.

STEP 2: PLACE BATTERIES IN REMOTE

- Remove the battery compartment cover from the back of the remote by pushing down on and sliding off the cover.
- Insert fresh batteries. Make sure that the polarities (+ and -) are aligned correctly.
- Replace the cover.

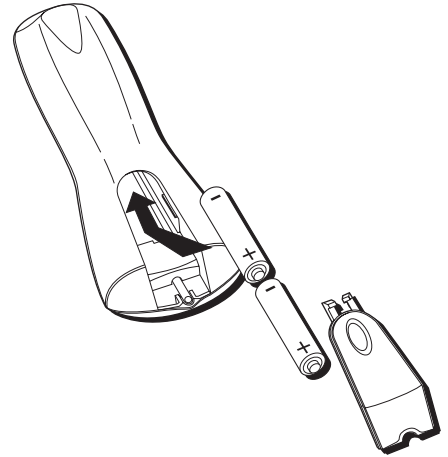

STEP 3: TURN ON THE MONITOR

Press TV on the remote, or press POWER on the monitor's front panel.

Pressing the TV button not only turns on the monitor, but puts the remote into TV mode, so that the buttons on the remote will control monitor functions.

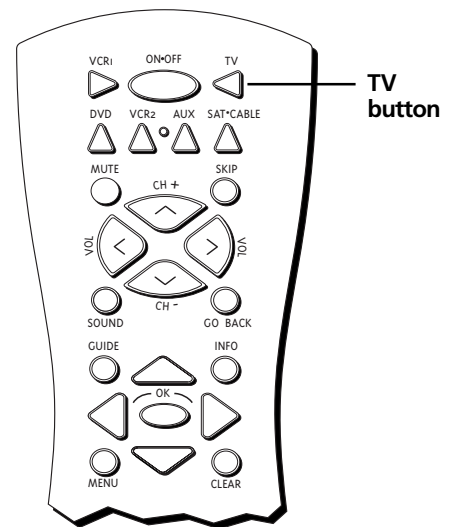

The Point and Select Navigation Method

You can "get around" in the menu system by using just a few buttons on the remote control. We call this the "Point and Select" method of navigation, and it has two steps.

1. **Point** to a menu item using the arrows on the remote.
To point up or down, press the up or down arrows. To point left or right, press the left or right arrows.
2. **Select** a menu item by pressing MENU or OK.
Selecting an item tells the monitor's menu system to go ahead and make the change or go to a place you have indicated.

STEP 4: SET UP THE GUIDE Plus+ GOLD SYSTEM

The first time you turn on the monitor, you will see the GUIDE Plus+ Gold screen. You need to set up the GUIDE Plus+ Gold system so it can display your local program listing and control your cable box and VCR.

To complete the GUIDE Plus+ Gold setup, the GUIDE Plus+ Gold G-LINK cable wand must be properly aligned with the remote sensor on your cable box and VCR if you have them. Refer to the *Making Connections* section for additional information.

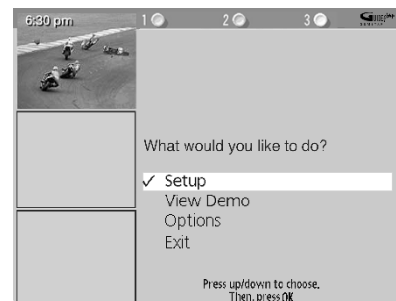

SETTING UP

Select your Country and enter your ZIP or Postal code.

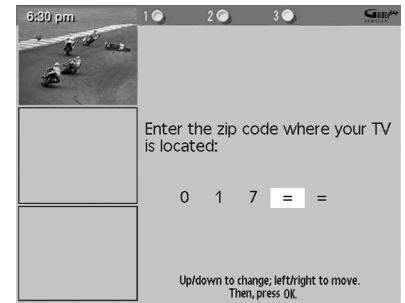
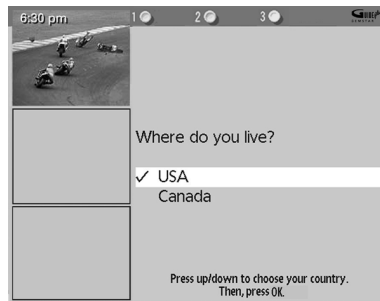

The next series of screens asks you about your cable TV setup. If you have a cable box, you need to set the GUIDE Plus+ Gold System to control it. Otherwise, it may not be able to locate and download program information.

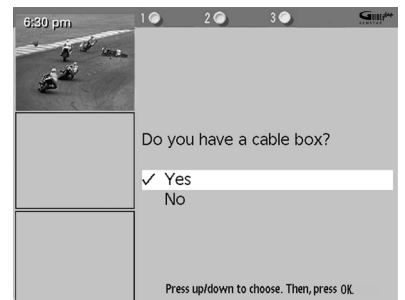
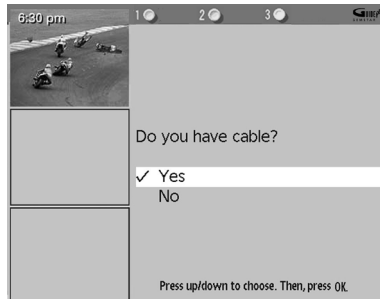

Tune your cable box to Channel 2 and then select the brand of your cable box from the choices available. The system then searches for the correct code to control your cable box. When your cable box switches to channel 9 it has located the correct code.

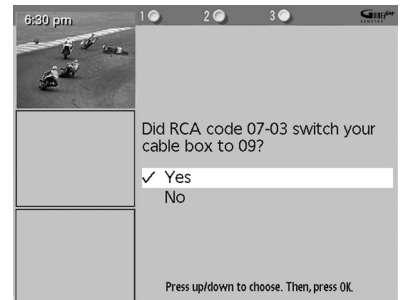
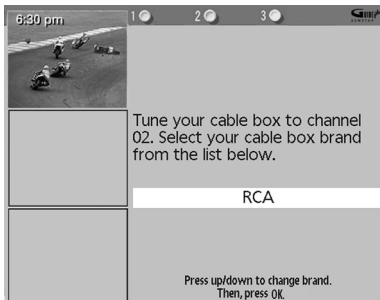

Select Yes if the cable box changed to channel 9, or No if it did not. If you select No, the system will try another code.

If the GUIDE Plus+ system cannot recognize either your cable box or VCR after several tries, a screen stating "Cable Box (VCR) test failed...Please consult your manual and try again" appears. You have a choice to either *Try Again* or *Skip Cable Box Setup*. If you get this message, you should also:

- Double check the brand of your cable box or VCR, and try entering it again.
- Check to make sure the G-LINK cable wand is positioned correctly.

If you choose to skip the cable box (or VCR) setup some features of the guide may not be available until you successfully complete this procedure.

SETTING UP

Once the correct model of cable box has been identified, you need to set the cable box's output channel. Enter the channel you use to view channels through your cable box—usually 3 or 4. Consult your cable box's instruction book or your cable company if you are not sure. Choose *0/AUX* to use VIDEO INPUT.

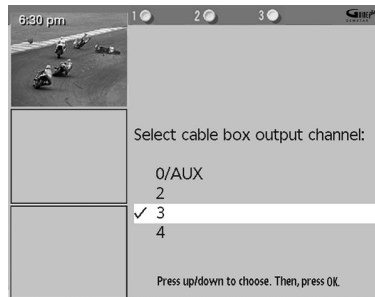

Select *Yes* if you have a VCR, or *No* if not. (Answering *No* automatically skips forward to the end of *GUIDE Plus+* setup.) Tune your VCR to channel 2 and turn it off. Find the brand of your VCR by using the up and down arrows.

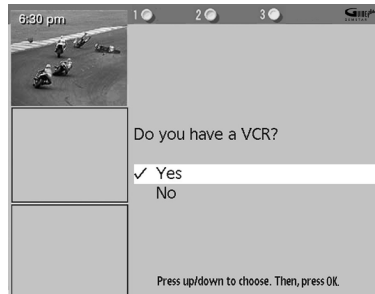

When the *GUIDE Plus+ Gold System* correctly identifies the correct code for your VCR, the VCR's tuner changes to channel 9. Select *Yes* if the VCR automatically changed to channel 9, or *No* if it did not. If you select *No*, the system will try another code.

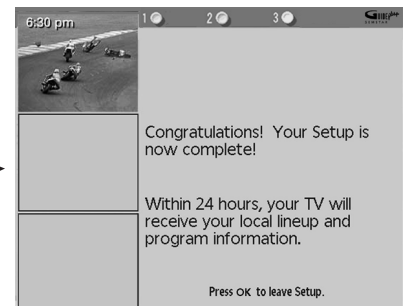
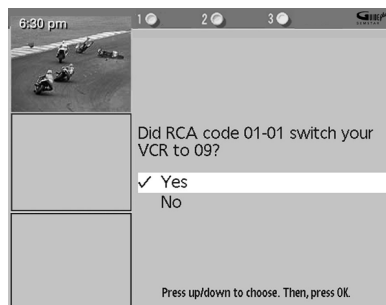

Remember:

- Leave your cable box turned ON to download program information.
- Leave your VCR turned OFF to record programs and download information.

Press OK to leave the *GUIDE Plus+ Gold System* setup.

STEP 5: RUN AUTO CHANNEL SEARCH

This is an important step because running Auto Channel Search searches for all the channels available through the antenna or cable input. When the monitor finds an active channel, it places it in the channel list; inactive channels (weak stations or channels with no signal at all) will be removed from the channel list. To run Auto Channel Search:

1. Press *MENU* on the remote and select *Channel*.
2. Select *Signal Type* and then choose whether you have cable or are using an off-air antenna.
3. Return to the *Channel* menu.
4. Select *Auto Channel Search*.
5. When the channel search is complete, exit the menu system.

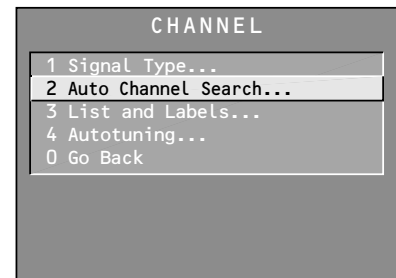

USING THE REMOTE

HOW TO USE YOUR UNIVERSAL REMOTE

This section defines the buttons of the remote and how to program it to control other components.

The universal remote can be programmed to control most brands of remote controllable VCRs, satellite receivers, and cable boxes. If you have an RCA, GE, or PROSCAN component, you probably don't need to program it at all.

1 MAKING CONNECTIONS



2 SETTING UP



3 USING THE REMOTE



4 MENUS AND FEATURES



5 REFERENCE

Modes of Operation

Because this universal remote can control several different components (DVD player, VCR, Cable Box, etc.) it uses operational modes triggered by the component buttons. For example if you want the remote to control the TV, you would press the TV button to put the remote into TV mode before you could control the TV.

USING THE REMOTE

REMOTE BUTTONS

ON•OFF When in TV mode, turns the monitor on and off. If in another device mode (VCR, DVD, SAT•CABLE, etc.) and programmed, will turn the device on and off. Press twice within two seconds to turn off most RCA, GE, and PROSCAN products at once.

VCR1 Puts the remote in VCR mode and if Autotuning is enabled, it will turn on the monitor and tune to the correct input channel.

TV Turns on the monitor and puts the remote in TV mode. Also displays channel information.

DVD Puts the remote in DVD mode and if Autotuning is enabled, it will turn on the monitor and tune to the correct input channel.

VCR2 Puts the remote in VCR2 mode and if Autotuning is enabled, it will turn on the monitor and tune to the correct input channel.

LED The LED light indicates programming mode when programming the remote to control components. Also lights when a valid code is sent while you are programming the remote.

AUX Puts the remote in AUX mode. Also, turns on the monitor.

SAT•CABLE Puts the remote in SAT•CABLE mode and if Autotuning is enabled, it will turn on the monitor and tune to the correct input channel.

MUTE Reduces the monitor's volume to its minimum level. Press again to restore the volume.

SKIP Press once before changing channels and the monitor will wait 30 seconds before returning you to the original channel. Press repeatedly to add more time.

CH + or CH - Scans up or down through the current channel list. Press once to change the channel up or down; press and hold to continue changing channels. In DVD mode, pressing CH buttons skips chapters.

VOL - or VOL + Decreases or increases the monitor's volume.

SOUND Press once to display the audio processor choice list. Point and select to choose a different processor or press CLEAR to exit.

GO BACK Returns you to the previous channel or previous screen in the menu system.

GUIDE Brings up and exits the GUIDE Plus+ Gold System. In SAT•CABLE mode, brings up available on-screen guides.

INFO Brings up channel information; press again to clear the screen.

Move (Arrows) Used to point to different items in the menu system and adjust the menu controls. Also moves the PIP window when no menus are on the screen.

OK When in the menu system, selects highlighted items or returns you to the previous menu.

MENU Brings up the Main menu and selects highlighted items. When in VCR mode, it functions as a PROGRAM button.

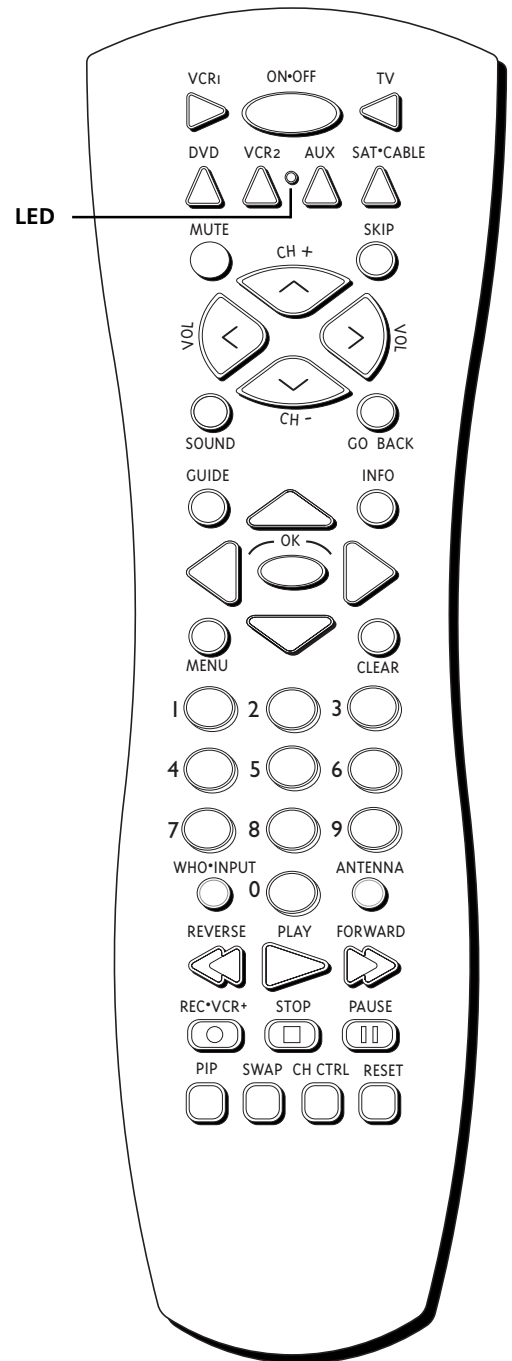

NOTE

The VCR1, DVD, VCR2, and SAT•CABLE buttons also turn on most RCA, GE, and PROSCAN products.

USING THE REMOTE

CLEAR Removes any menu or display from the screen and returns you to normal viewing.

(0-9) Number Buttons Enters channel numbers and time settings directly through the remote control. To enter a two-digit channel, press the two digits. To enter a three-digit channel, press and hold the "1" button until "1" and two dashes (--) appear, then add the second two. Example: to tune to channel 123, press and hold 1 until "1--" appears, release the 1 button and then press 2, and 3.

WHO•INPUT In TV mode, press to toggle through the available input sources (VID1, VID2, VID3, FRONT, last channel, VGA1, VGA2, component input). In SAT mode, press to select available channel lists (RCA, GE, and PROSCAN products only).

ANTENNA Functions as TV/VCR button in VCR mode and TV/receiver button in satellite mode.

REVERSE, PLAY, FORWARD, REC•VCR+, STOP, PAUSE If programmed, provides transport control for some remote-controllable VCRs, DVD players, laserdisc players, tape decks, and CD players. Pressing REC•VCR+ when using the GUIDE Plus+ System sets the VCR to record a program.

PIP Brings up the small picture-in-picture window. Press again to remove the PIP window. (See "PIP Feature" later in this manual for more information about using PIP.)

SWAP Swaps the main picture with the PIP window.

CH CTRL Selects the picture window, (that is, the main or PIP window) to be changed by the CH ^ (channel up) or CH v (channel down) buttons.

RESET Resets picture quality controls to the *Bright Lighting* Picture Control Preset. Point and select to choose a different Picture Control Preset. Also used to reset the settings in a menu, such as the Parental Controls menu.

USING THE WHO•INPUT BUTTON

Use the WHO•INPUT button to scroll through the available input channels and view components you have connected to the monitor.

1. Press TV to place the remote in TV mode. Make sure that the component you want to view is turned ON.
2. Press WHO•INPUT to tune to an available input channel.
3. Continue to press the WHO•INPUT button to scroll through the input channels.

PROGRAMMING THE REMOTE

The universal remote can be programmed to control most brands of remote controllable VCRs, satellite receivers and cable boxes. The remote is already programmed to control most RCA, GE, and PROSCAN TVs, VCRs, DVD players, laserdisc players and satellite receivers.

Modes of Operation

Because this universal remote can control several different components (DVD player, VCR, Cable Box, etc.) it uses operational modes triggered by the component buttons. For example if you want the remote to control the TV, you would press the TV button to put the remote into TV mode before you could control the TV.

USING THE REMOTE

TESTING THE REMOTE

To determine whether the universal remote needs to be programmed, turn a device ON, such as a VCR, point the remote at the VCR, and press the VCR1 button. Then press POWER or CH ^ (channel up) or CH v (channel down) to see if the VCR responds to the remote commands. If not, the remote needs to be programmed.

PROGRAMMING THE REMOTE

Using Automatic Code Search

The following instructions can be used to program the remote to control each of the devices connected to your monitor. If you want to exit the automatic code search without programming any of your devices, press and hold CLEAR until the LED turns off.

1. Turn on the device you want to control (VCR, digital satellite receiver, etc.).
2. Press and hold the button you want to program, such as VCR1, DIRECTV, etc. (Note that the AUX button cannot be automatically programmed. Use the direct entry method instead.) While holding the device button, press and hold ON•OFF until the red light on the remote turns on, then release both buttons.
3. Point the remote at the device, press and release PLAY, then wait 5 seconds or until the LED stops flashing.

At this point the remote is searching for the correct code to program. If, after 5 seconds or until the LED stops flashing, the device you want to control does not turn off, press PLAY again to tell the remote to search the next set of codes.

Continue pressing PLAY until the device turns off or you have searched through all of the codes. There are 20 total sets of codes. If the device does not turn off after pressing PLAY 20 times, then the remote cannot control that particular device.

If the device you want to control *does* turn off:

1. Press and release REVERSE, then wait 2 seconds. Repeat this step until the device turns back ON.
2. Press and hold STOP until the red light on the remote turns off.

Using Direct Entry

1. Turn on the component to be programmed.
2. Look up the brand and code number(s) for the component on the code list on the last page of this section.
3. Press and hold the button on the remote you want to program.
4. Enter the code from the code list.
5. Release button, and then press ON•OFF to see if the component responds to the remote commands. If it doesn't, try pressing the component button and then ON•OFF again.

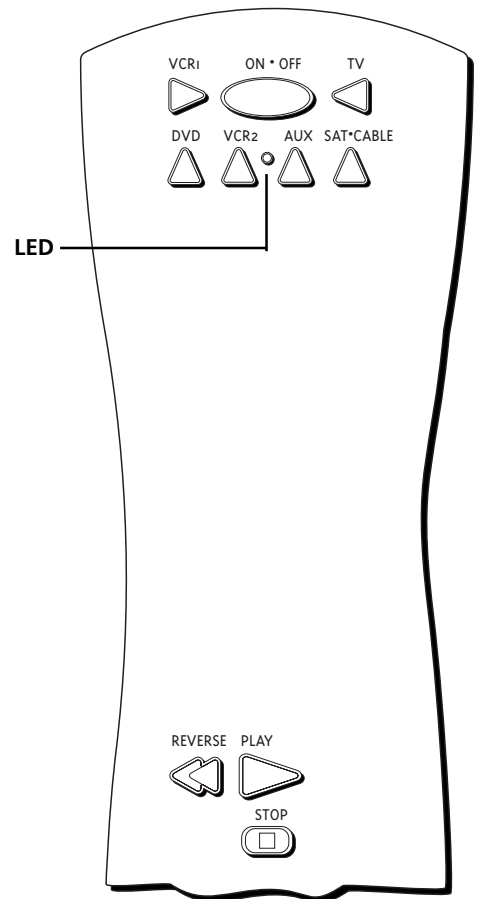

You'll use these buttons when you program the remote.

The remote may not operate all models of all brands.

USING THE REMOTE

6. If you get no response, repeat these steps using the next code listed for your brand, until the component responds to the remote commands.

USING THE REMOTE TO CONTROL A DEVICE

Once the remote has been programmed successfully, you are ready to use it to control your devices.

To operate the device:

1. Press the device button (TV, VCR1, VCR2, DVD, AUX, or SAT•CABLE) to set the remote to control the device.
2. Press ON•OFF to turn the device ON or OFF.
3. Use the remote buttons that apply to that device.

MODES OF OPERATION

Because this universal remote can control several different components (DVD player, VCR, Cable Box, etc.) it uses operational modes triggered by the component buttons. For example if you want the remote to control the monitor, you would press the TV button to put the remote into TV mode before you could control the monitor.

FRONT PANEL

If you cannot locate your remote you can use the front panel of your monitor to operate many of the monitor's features.

MENU/OK Brings up the Main menu. When in the menu system, it selects highlighted items. Also returns you to the previous menu.

CH v Scans down through the current channel list. In the menu system, it points down to items and adjusts menu controls.

CH ^ Scans up through the channel list. In the menu system, it points up to items and adjusts menu controls.

VOL - Decreases the volume. When in the menu system, VOL - is used to point left to items and adjust menu controls.

VOL + Increases the volume. When in the menu system, VOL + is used to point right to items and adjust menu controls.

POWER Turns the monitor on and off.

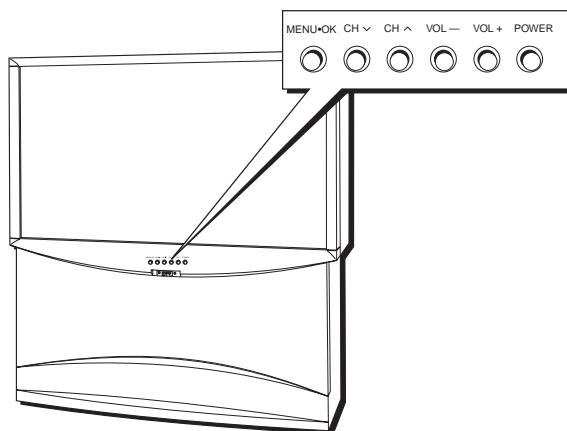

The front panel illustration below shows a typical front panel layout. The exact look may be different from those on the front of your monitor.

If you use the Channel Block feature, the front panel no longer provides access to the menus. The Front Panel Block feature disables all front panel buttons. For more information, see "Parental Controls," in the *Menus and Features* section.

USING THE REMOTE

VCR

Admiral	2131
Adventura	2026
Aiko	2027
Aiwa	2002, 2026
Akai	2003, 2004, 2005, 2007, 2008, 2111, 2112, 2113
American High	2021
Asha	2013
Audio Dynamics	2009, 2010
Audiovox	2014
Bell & Howell	2011
Beaumarck	2013
Broksonic	2012, 2025
Calix	2014
Candle	2013, 2014, 2015, 2016, 2017, 2018, 2019
Canon	2021, 2022, 2114
Capehart	2020, 2110
Carver	2062
CCE	2027, 2061
Citizen	2013, 2014, 2015, 2016, 2017, 2018, 2019, 2027
Colortyme	2009
Colt	2061
Craig	2013, 2014, 2023, 2061
Curtis-Mathes	2000, 2002, 2009, 2013, 2016, 2018, 2021, 2022, 2024, 2115
Cybernex	2013
Daewoo	2015, 2017, 2019, 2025, 2026, 2027, 2028, 2110
Daytron	2110
Dbx	2009, 2010
Dimensia	2000
Dynatech	2002, 2026
Electrohome	2014, 2029
Electroponic	2014
Emerson	2002, 2012, 2014, 2015, 2021, 2024, 2025, 2026, 2029, 2030, 2032, 2033, 2034, 2035, 2036, 2037, 2038, 2039, 2040, 2041, 2042, 2044, 2045, 2047, 2065, 2105, 2113, 2116, 2117, 2130
Fisher	2011, 2023, 2048, 2049, 2050, 2051, 2052, 2118
Fuji	2021, 2119
Funai	2002, 2026
Garrard	2026
GE	2000, 2001, 2013, 2021, 2022, 2053, 2115, 2120
Goldstar	2009, 2014, 2018, 2054, 2121
Gradiente	2026
Harley Davidson	2026
Harman Kardon	2009
Harwood	2061
Headquarter	2011
Hitachi	2002, 2055, 2056, 2057, 2107, 2111, 2120, 2122
Hi-Q	2023
Instant Replay	2021
JCL	2021
JC Penney	2009, 2010, 2011, 2013, 2014, 2021, 2022, 2055, 2056, 2058, 2059, 2060, 2107, 2118
Jensen	2055, 2056, 2111
JVC	2009, 2010, 2011, 2018, 2058, 2111, 2123
Kenwood	2009, 2010, 2011, 2016, 2018, 2058, 2111, 2123
KLH	2061
Kodak	2014, 2021
Lloyd	2002, 2026
Logik	2061
LXI	2014
Magnavox	2021, 2022, 2062, 2063, 2104, 2108, 2124
Magnin	2013
Marantz	2009, 2010, 2011, 2016, 2018, 2021, 2058, 2062, 2064
Marta	2014
Masushita	2021
MEI	2021
Memorex	2002, 2011, 2013, 2014, 2021, 2023, 2026, 2104, 2131
MGA	2029, 2065, 2113
MGN Technology	2013
Midland	2053
Minolta	2055, 2056, 2107
Mitsubishi	2029, 2055, 2056, 2065, 2066, 2067, 2069, 2070, 2071, 2072, 2073, 2074, 2106, 2113, 2123

Montgomery Ward	2075, 2131
Motorola	2021, 2131
MTC	2002, 2013, 2026
Multitech	2002, 2013, 2016, 2026, 2053, 2061
NEC	2009, 2010, 2011, 2016, 2018, 2058, 2064, 2076, 2078, 2079, 2111, 2123
Nikko	2014
Noblex	2013
Olympus	2021
Optimus	2014, 2131
Optonica	2096
Orion	2035
Panasonic	2021, 2022, 2109, 2125, 2126, 2127
Pentax	2016, 2055, 2056, 2107, 2120
Pentax Research	2018
Philco	2021, 2022, 2062, 2063
Philips	2021, 2062, 2096, 2124
Pilot	2014
Pioneer	2010, 2055, 2080, 2081, 2123
Portland	2016, 2017, 2019, 2110
Proscan	2000, 2001
Protec	2061
Pulsar	2104
Quarter	2011
Quartz	2011
Quasar	2021, 2022, 2125
RCA	2000, 2001, 2003, 2013, 2021, 2055, 2056, 2082, 2083, 2084, 2085, 2086, 2087, 2088, 2089, 2090, 2091, 2107, 2115, 2120, 2125
Radioshack/Realistic	2002, 2011, 2013, 2014, 2021, 2022, 2023, 2026, 2029, 2049, 2050, 2096, 2131
Radix	2014
Randex	2014
Ricoh	2128
Runco	2104
Samsung	2005, 2013, 2015, 2033, 2053, 2112
Sankey	2132, 2104
Sansui	2010, 2092, 2111, 2123
Sanyo	2011, 2013, 2023
Scott	2012, 2015, 2025, 2032, 2035, 2038, 2065, 2093, 2116
Sears	2011, 2014, 2021, 2023, 2048, 2049, 2050, 2051, 2055, 2056, 2107, 2118
Sharp	2002, 2017, 2029, 2094, 2095, 2096, 2131
Shintom	2004, 2056, 2061, 2098
Shogun	2013
Signature	2002, 2131
Singer	2021, 2061, 2128
Sony	2002, 2004, 2098, 2099, 2119, 2128
STS	2021, 2107
Sylvania	2002, 2021, 2022, 2026, 2062, 2063, 2065, 2124
Symphonic	2002, 2026
Tandy	2002, 2011
Tashiko	2014
Tatung	2058, 2111
TEAC	2002, 2026, 2058, 2085, 2111
Technics	2021, 2109
Teknika	2002, 2014, 2021, 2026, 2100, 2129
Tmk	2013, 2024, 2047
Toshiba	2015, 2049, 2051, 2055, 2065, 2093, 2116
ToteVision	2013, 2014
Unitech	2013
Vector Research	2009, 2010, 2015, 2016
Victor	2010
Video Concepts	2009, 2010, 2015, 2016, 2113
Videosonic	2013
Wards	2002, 2013, 2014, 2015, 2021, 2023, 2026, 2029, 2055, 2056, 2061, 2096, 2101, 2102, 2103, 2107, 2116, 2131
XR-1000	2021, 2026, 2061
Yamaha	2009, 2010, 2011, 2018, 2058, 2111
Zenith	2004, 2098, 2104, 2119, 2128

Audio

(For RCA and Dimensia brands only)

AM/FM	4003
Aux	4004
Phono	4005
CD	4007
Tape	4006

Cable Boxes

ABC	5002, 5003, 5004, 5005, 5006, 5007, 5053
Antronix	5008, 5009
Archer	5008, 5009, 5010, 5011
Cabletenna	5008
Cableview	5008
Century	5011
Citizen	5011
Colour Voice	5012, 5013
Comtronics	5014, 5015
Contec	5016
Eastern	5017
Garrard	5011
GC Electronics	5009
Gemini	5018, 5019, 5049
General Instrument	5003
Hamlin	5020, 5021, 5022, 5035, 5045
Hitachi	5003
Hytex	5002
Jasco	5011
Jerrold	5003, 5005, 5007, 5018, 5023, 5024, 5046, 5053
Magnavox	5025
Memorex	5026
Movie Time	5002, 5027, 5028
NSC	5002, 5027, 5028
Oak	5002, 5016, 5029
Panasonic	5048, 5052
Paragon	5026
Philips	5011, 5012, 5013, 5019, 5025, 5030, 5031, 5032
Pioneer	5033, 5034
Pulsar	5026
RCA	5047, 5049, 5052
Realistic	5009, 5049
Regal	5022, 5035
Regency	5017
Rembrandt	5003
Runco	5026
Samsung	5014, 5034
Scientific Atlanta	5006, 5036, 5037, 5038
Signal	5014, 5018
Signature	5003
SL Marx	5014
Sprucer	5052
Starcom	5007, 5018, 5053
Stargate	5014, 5018
Starquest	5018
Tandy	5040
Teleview	5014
Tocom	5004, 5023, 5041
Toshiba	5026
Tusa	5018
TV86	5027
Unika	5008, 5009, 5011
United Artists	5002
United Cable	5053
Universal	5008, 5009, 5010, 5011
Videoway	5044
Viewstar	5015, 5025, 5027, 5040
Zenith	5026, 5050, 5051

Satellite Receivers

Chapparral	5056, 5057
Drake	5058, 5059
GE	5000, 5001
General Instruments	5060, 5061, 5062
Panasonic	5075
Primostar	5076
Proscan	5000, 5001
RCA	5000, 5001
Realistic	5063
Sony	5072
STS1	5064
STS2	5065
STS3	5066
STS4	5067
Toshiba	5068, 5073
Uniden	5069

MENUS AND FEATURES

USING THE MONITOR

This section explores the features and menus of your monitor beginning with some information on using menus and control panels.

Each menu is then outlined and special features are detailed in order to help you get the most from your monitor.

1 MAKING CONNECTIONS



2 SETTING UP



3 USING THE REMOTE



4 MENUS AND FEATURES



5 REFERENCE

MENUS AND FEATURES

AUDIO MENU

Mute Press OK to reduce the monitor's volume to its minimum level. Press OK again to restore the volume. From the front panel, you can quickly press MENU•OK three times to mute the volume.

Tone Controls Displays the slider controls for adjusting the monitor's treble, bass and balance.

Audio Processor Displays a choice list of available audio modes, which control the way the sound comes through your speakers. You can also directly access this menu by pressing the SOUND button on your remote.

Mono Plays the sound in mono only. Use this setting when receiving broadcasts with weak stereo signals.

Stereo Splits the incoming stereo audio signal into left and right channels. Most TV programs and recorded materials have stereo audio. The monitor displays the word STEREO in the channel marker when you tune to a program that is broadcast in stereo.

SRS Stereo (•) SRS* technology is an audio processing technology that adds greater depth and stereo separation to stereo audio signals.

SRS Stereo (•) - Focus This technology focuses audio signals by adding treble and making dialog more understandable.

Second Audio Program (SAP) Plays the program's audio in a second language, if one is available. The monitor displays the word SAP in the channel marker when you tune to a program that is broadcast with SAP information. SAP audio is broadcast in mono. SAP is also used to broadcast a program's audio with descriptions of the video for the visually impaired.

Speakers Displays a choice list that lets you turn the monitor's internal speakers on or off.

Sound Logic™ Sound Logic monitors a program's audio track and limits the volume to a maximum volume range. Whenever you adjust the volume on the monitor, the maximum volume range adjusts, too.

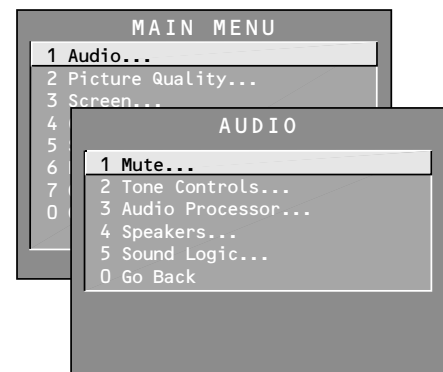

* SRS, SRS Stereo, SRS Stereo Focus, Sound Retrieval System and the SRS logo are registered trademarks of SRS Labs, Inc.

MENUS AND FEATURES

PICTURE QUALITY MENU

Picture Controls Displays the five slider controls for adjusting the way the picture looks. You can adjust and save different settings for each input.

Contrast Adjusts the difference between the light and dark areas of the picture.

Color Adjusts the richness of the color.

Tint Adjusts the balance between the red and green levels.

Black Level Adjusts the brightness of the picture.

Sharpness (Not available in Text mode) Adjusts the crispness of edges in the picture.

When exiting this menu the *Save Personal Picture Preset Choice List* will appear. You can choose either *Yes* or *No*.

Picture Presets Displays a choice list that lets you select one of three preset picture settings: *Bright Lighting*, *Normal Lighting*, *Soft Lighting* or *Personal Picture Preset*. Based on the degree of lighting in your room, you should choose *Bright*, *Normal*, or *Soft Lighting*. After you select one, the contrast, color tint, black level, and sharpness settings found under the *Picture Settings* menu are automatically adjusted according to your selection.

Auto Color Displays a choice list that lets you turn on the feature that automatically corrects the color of the picture. (This is especially useful for tracking realistic flesh tone colors as you switch from channel to channel.) Choose *On* or *Off*, depending on your preference. *Auto Color* is not available for VGA or component video.

Color Warmth Displays a choice list that lets you adjust three automatic color adjustments: *Cool* for a more blue palette of picture colors; *Normal*; and *Warm* for a more red palette of picture colors. The warm setting corresponds to the NTSC standard of 6500 K and *Normal* to 9300 K.

Video Noise Reduction Displays a choice list that lets you adjust the feature that automatically reduces noise from the picture. *Video Noise Reduction* is not available in Text mode when in VGA mode.

Picture Mode The picture mode control panel appears when the monitor is tuned to a VGA input.

Computer/Text is the recommended input and setting for most PC connections when viewing text and graphics. Text may appear crisper in Text mode.

Video is the default setting for the VGA2 input. This input and setting is recommended in such instances as HD receiver connections. The appearance of text in Video mode may be improved by lowering the picture's sharpness and contrast (see above).

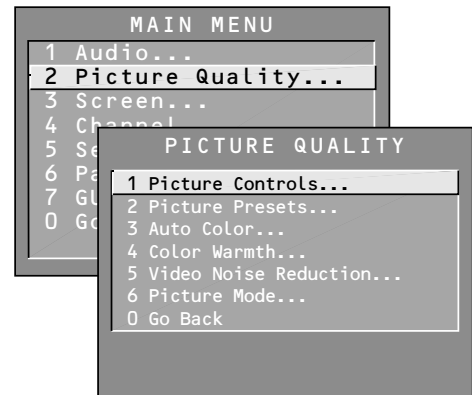

If you choose *Personal Picture Preset*, you can customize color, tint, black level, and sharpness to your desired level, and the television "saves" those settings. After you've done this, it allows you to go back into the menu and select *Bright*, *Normal*, or *Soft Lighting* when you need to without losing your customized settings. For example, if you normally use *Personal Picture Preset* but wanted to watch a show in *Bright Lighting*, watch the show, and then afterwards return to your customized settings by choosing *Personal Picture Preset* again.

MENUS AND FEATURES

SCREEN MENU

Closed-Caption Display Displays a choice list that lets you choose the way closed captioning information is shown on the screen. Closed-captioning is not available with the VGA inputs.

Off No captioning information displayed.

On Always Captioning information shown always, when available.

On when sound is muted Displays captioning information, when available, whenever the monitor's sound is muted by pressing the MUTE button. The captioning information is not displayed when the sound is not muted.

Many programs are encoded with closed captioning information, which lets you display the audio portion of a program as text on the monitor screen. Closed captioning is not available on all channels at all times. Only specific programs encoded with closed captioning information are applicable. When a program is closed captioned, the letters CC are displayed in the channel marker.

Closed-Caption Mode Displays a choice list that lets you choose which captioning mode is used for displaying captioning information. If you are unsure of the differences among the modes, you may prefer to leave the closed captioned mode set to CC1, which displays complete text of the program in the primary language in your area.

Menu Background Color This menu item lets you choose between blue and transparent menu backgrounds.

Adjust Projection TV Lets you adjust the TV's three colors. *Automatic Convergence* will cause the monitor to self-correct color images. This process results in a temporarily blank screen, may take several minutes, and should be completed for each mode: NTSC, VGA, HDTV, and SVGA. Note that Automatic Convergence covers only the mode selected at the time. To Auto Converge for another mode, enter the mode and select *Automatic Convergence* again. Selecting *Red Convergence* or *Blue Convergence* lets you align the red and blue images with the green image. For best results, run Automatic Convergence after the TV has been on for at least 30 minutes.

***Picture Position** This menu item appears when the monitor is tuned to a VGA input. This control adjusts the horizontal and vertical position of the main picture window. Use the arrows on the remote control to move the window. Press OK to set the positioning.

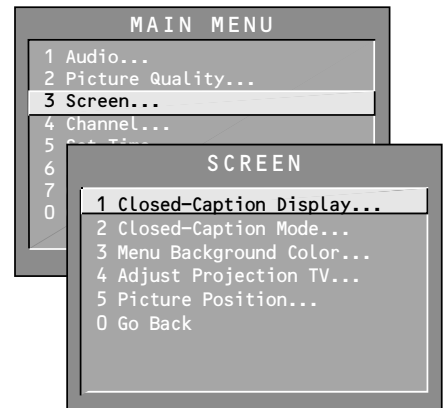

Screen menu when tuned to a VGA input.

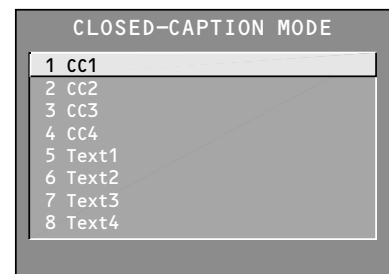

Your Projection TV has three color projection tubes—one for red, one for green, and one for blue. When the tubes' images are precisely aligned, they create the color images you see on the TV screen. Over time, the picture can drift out of alignment due to normal component aging, bumps, and vibrations or moving the TV. If you notice rings or halos around objects in the picture, you may want to try adjusting Projection TV settings.

*This option is not available when an HD receiver or computer of similar frequency is connected to one of the (S)VGA inputs.

MENUS AND FEATURES

CHANNEL MENU

Signal Type Displays a choice list that lets you select the current antenna type. Note that if you have set up the GUIDE Plus+ System, Signal Type does not appear in the Channel menu.

UHF/VHF Antenna Choose this if you are currently using an off-air antenna for TV signals.

Cable TV Choose this if you are currently using cable or a cable box for TV signals.

Auto Channel Search Tells the monitor to search automatically for all the channels available through the antenna input. When the monitor finds an active channel, it places it in the channel list; inactive channels (weak stations or channels with no signal at all) will be removed from the channel list. Video Input channels can also be added later in the List and Labels control panel. Note that if you have set up the GUIDE Plus+ System and specified that you are using a cable box, Auto Channel Search does not appear in the Channel menu.

List and Labels Displays a control panel that lets you custom-build your channel list and choose a six-character label for up to 45 channels. Follow the on-screen directions to enter your channels and other information.

Channel Number Use the up and down arrows to scroll up and down through the channel scan list. You can enter the channel number directly using the number buttons.

Channel List Only the channels included in the Normal list are available when you scan up and down using the CH buttons. Use the up and down arrows to indicate whether the channel number indicated is included (Yes) or is not included (No) in the Normal channel list.

Channel Labels You can enter a six-character label for up to 45 channels. Use the CH ^ (channel up) or CH v (channel down) buttons to change channels in the Channel Number field. This works even if you're not in the Channel Number field. Or, enter the channel number directly using the number buttons on the universal remote. To enter a number greater than 99, press and hold "1" to enter the hundreds digit, then press the two remaining numbers. The List and Labels feature can also be accessed from the Channel menu. Because this procedure can be time consuming, feel free to skip this step and come back to it later.

1. Use the left and right arrows to point to the three different areas of the control panel (called "fields").
2. Use the up and down arrows to scroll through the numbers (or use the digit keys on the remote) and letters and select Yes or No in the Channel List field. You may wish to refer to the TV station call letters listed in your newspaper's TV section for ideas on labelling the channels.
3. Repeat this process for each of your channels. Then press MENU or OK to continue. The monitor can store in memory as many as 45 labels.

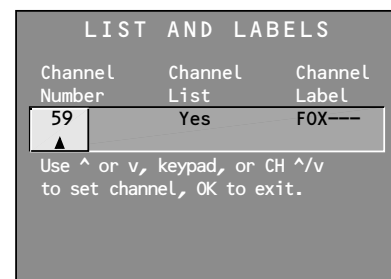
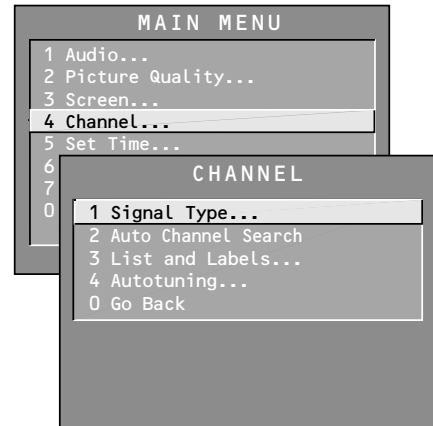

MENUS AND FEATURES

Autotuning Displays a choice list that lets you set up the monitor to automatically tune to the correct input channel when you press a component button (VCR1, VCR2, DVD, or SAT•CABLE) on the remote.

Set VCR1 Channel Displays a choice list that lets you select the channel that the monitor tunes to when you press the VCR1 button.

Set VCR2 Channel Displays a choice list that lets you select the channel that the monitor tunes to when you press the VCR2 button.

Set DVD Channel Displays a choice list that lets you select the channel that the monitor tunes to when you press the DVD button.

Set SAT/CABLE Channel Displays a choice list that lets you select the channel that the monitor tunes to when you press the SAT•CABLE button.

After you have selected the device button you want to Autotune, you need to select the input you want the monitor to tune to when you press that button. The available options include:

Not Connected Choose this if you do not have a component connected to an antenna or video input on the back of the monitor, or if you don't want the monitor to tune to a channel when the particular component button is pressed.

Channel 3 or 4 Choose this if your component is connected to the antenna jack on the back of the monitor, and you want the monitor to tune to channel 3 or 4 when you press the specified component button. Reminder: Make sure the component's Ch 3/4 switch, usually on the back of the component, is set to the corresponding channel.

Video 1, Video 2, Video 3, or Front Input Choose this if your component is connected to the INPUT 1, INPUT 2, INPUT 3 or Front Input jacks of the monitor and you want the monitor to tune to VID1, VID2, VID3 or FRNT input channel when you press the specified component button. (If you connect S-video cables, the channel marker displays SVID1, SVID2 or SVID3.)

Component Video Input Choose this if your compatible video source, such as a DVD player or digital TV converter box, is connected to the three component video jacks on the back of the monitor and you want the monitor to tune to component video input channel when you press the specified component button.

(S)VGA 2 Input Choose this if your component is connected to the (S)VGA 2 input on the back of the monitor and you want the monitor to tune to the (S)VGA 2 input channel when you press the specified component button.

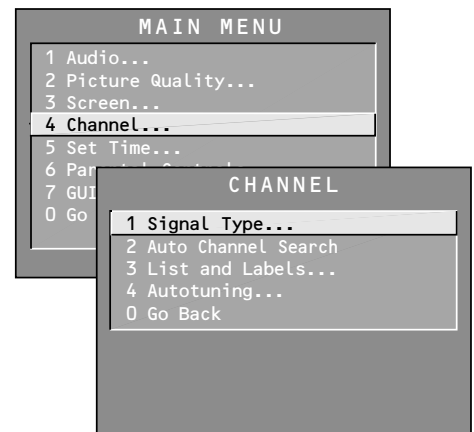

SET TIME MENU

The Set Time menu displays a control panel that lets you enter the current time. The on-screen directions guide you through the steps needed to set the time. If your GUIDE Plus+ Gold System is set up, then it will automatically update your time and this option will not appear in the menu.

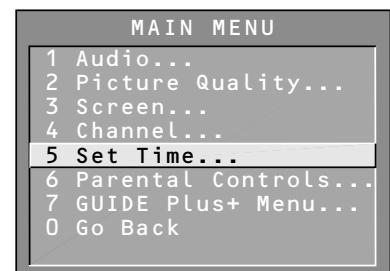

MENUS AND FEATURES

PARENTAL CONTROLS AND V-CHIP

The Parental Controls menu allows you to program your monitor so that children cannot see certain programs, channels, or use the front panel controls.

The first three choices in the Parental Controls menu involve software inside your monitor (called V-Chip) which allows you to “block” TV programs and movies based on violence, sex, or other content you may believe children should not view. In other words, it lets you program your monitor so it will not display certain programs. Once you block programs, you or other adults are not limited to only parent-approved programs; you can “unblock” programs by entering a password.

The V-Chip software inside your TV comes turned “off,” so if you choose not to implement it, you can just ignore it.

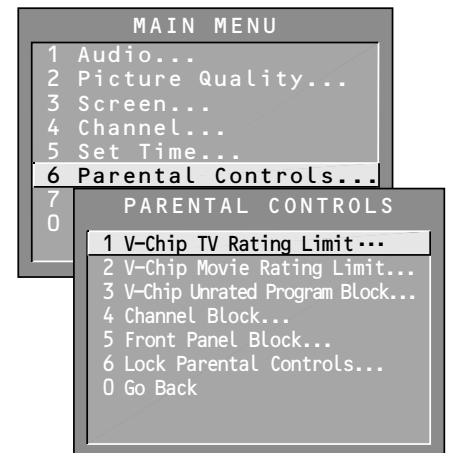

When turned “on,” the V-Chip software reads a code that most broadcasters send with programs. That code tells the V-Chip software the program’s age-based rating (TV-MA, TV-14, etc.) and content themes (Violence (V), Adult Language (L), etc.). If you have blocked the rating and/or content themes that the program contains, you will receive the message, “This channel is not approved for viewing,” when you turn to that particular channel. Broadcasters are not required to provide content themes, so programs received with no content themes will only be blocked if you block their age-based rating. You can also block out programs that have been given a rating of “Not Rated,” and programs that are considered “unrated” because no code has been sent by the broadcaster.

The TV age-based ratings and content themes you can block are listed in the table below.

Age-Based Rating	Description and Content Themes for Age-Based Ratings
TV-MA	Mature Audience Only. Specifically designed to be viewed by adults and may be unsuitable for children under 17. It contains one or more of the following content themes: crude indecent language (L), explicit sexual activity (S), or graphic violence (V).
TV-14	Parents Strongly Cautioned. Contains some material that many parents would find unsuitable for children under 14. Parents are strongly urged to exercise greater care in monitoring this program and are cautioned against letting children under the age of 14 watch unattended. This program contains one or more of the following content themes: intensely suggestive dialogue (D), strong coarse language (L), intense sexual situations (S), or intense violence (V).
TV-PG	Parental Guidance Suggested. Contains material that parents may find unsuitable for younger children. Many parents may want to watch it with their younger children. The program contains one or more of the following content themes: some suggestive dialogue (D), infrequent coarse language (L), some sexual situations (S), or moderate violence (V).
TV-G	General Audience. Most parents would find this program suitable for all ages.
TV-Y7	Directed to Children 7 years and older. Designed for children ages 7 and above. It may be more appropriate for children who have acquired the developmental skills needed to distinguish between make-believe and reality. Themes and elements in this program may include mild fantasy violence (FV) or comedic violence, or may frighten children under the age of 7.
TV-Y	All Children. Themes and elements in this program are designed for a young audience, including children from ages 2-6. It is not expected to frighten younger children.

MENUS AND FEATURES

V-CHIP TV RATING LIMIT

The V-Chip TV Rating Limit lets you decide what TV programs can and cannot be viewed.

To set TV programming limits:

1. Choose *Parental Controls* from the Main menu. If Parental Controls have previously been locked, you must enter your password. If they are not locked, you will get a message reminding you that your limits will not be effective until you lock Parental Controls.
2. Press MENU to continue.
3. Highlight and select *V-Chip TV Rating Limit*.
4. Once you get to the V-Chip TV Rating Limit screen, use the arrows and OK on your remote to change the status of a TV program rating or content theme from *View* to *Block*.

The following sections give you more details about how to change the status of TV program limits.

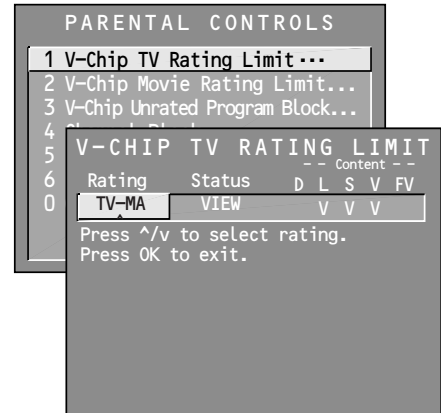

The Ratings Limits Screen

Below is an example of where items are located within the Rating Limits screen.

Rating Field

Lets you select from a list of age-based ratings you can block or view.

Rating Status Field

Lets you select whether the status of the age-based rating limit to the left is View or Block.

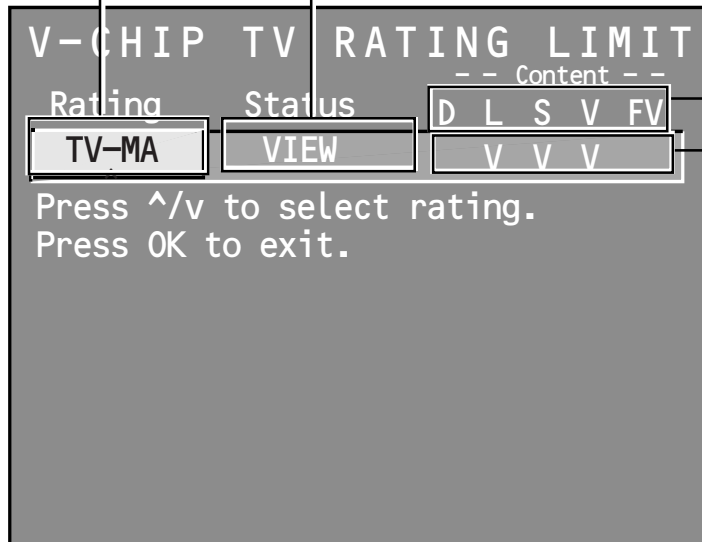

Content Themes

Lists the content themes you can block or view.

Content Status Fields

Lets you select which content themes to view for the selected rating, and whether the status of the content theme is currently View (V) or Block (B).

MENUS AND FEATURES

Blocking Age-Based Ratings

You can automatically block all program ratings above a specified age-based rating level. For example, if you only want your child to watch programs that have a TV-G rating and lower (in other words, you want the child to watch TV-G, TV-Y7, and TV-Y), then you need to block out other programming with higher ratings.

To block programs with higher ratings:

1. First, determine the lowest level rating you do not want the child to watch.
2. Use the left and right arrows to highlight the Rating Field.
3. Use the up and down arrows on the remote to scroll through the age-based rating limits. Keep scrolling until the rating corresponding with the lowest rating you do not want the child to watch appears.

In the example discussed above, you would scroll through the rating field until TV-PG appears, since the highest rating you want the child to watch is TV-G.

4. Use the right arrow to move the yellow highlight to the rating status field.
5. Press the up or down arrow to toggle between *View* and *Block*. The status for the rating listed to the left and all higher ratings automatically changes to *Block* (and *B*).

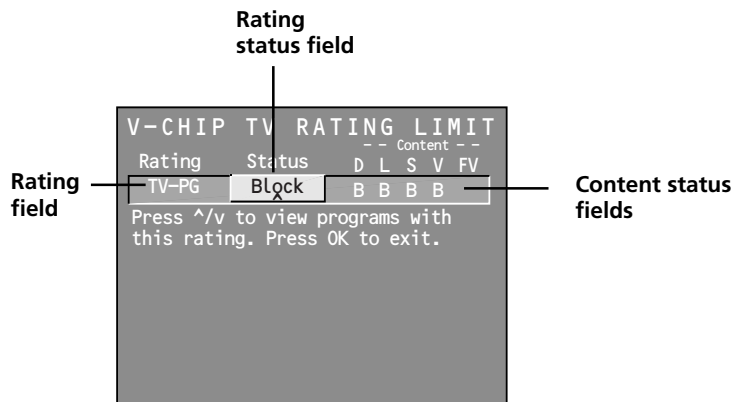

6. Press MENU or OK on the remote to return to the menu or exit the screen when you are finished.
7. Select Lock Parental Controls from the Parental Controls menu. Enter a password, and if you have not already set your password, you will be prompted to enter it again to confirm.

When you change the status of a rating to *Block*, the system will automatically block higher ratings and all corresponding content themes.

Hierarchy of Age-Based Ratings

TV-MA	Mature Audience Only
TV-14	Parents Strongly Cautioned
TV-PG	Parental Guidance Suggested
TV-G	General Audience
TV-Y7	Directed to Children 7 Years and Older
TV-Y	All Children

MENUS AND FEATURES

Viewing Age-Based Ratings

After you block age-based ratings, you have the option of changing some of the ratings back to *View*.

1. Determine which blocked rating you want to view.
2. Use the left and right arrows to highlight the Rating Field.
3. Use the up and down arrows to select the rating whose status is *Block*.
4. Press the right arrow to move the yellow highlight to the rating status field.
5. Press the up or down arrows to toggle between *View* and *Block*.

Note that the content status fields corresponding to the unblocked rating become *View* as well. They and the age-based rating status are the only fields that automatically change back to *View* when you complete this process.

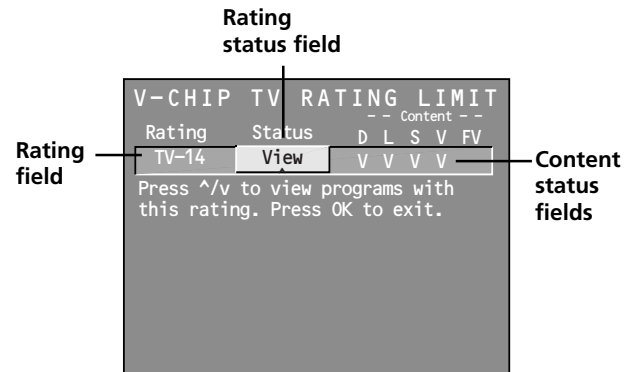

You must remember to Lock Parental Controls for rating limits to take effect.

Blocking Specific Content Themes

You can block programs based on their content. (Content is represented by the D, L, S, V, and FV on your screen. See the beginning of this section for details.) When you block a content theme for a particular rating, you automatically block that content theme for higher rated programs as well.

For example, if you do not want your child to watch programs that have adult language (L) rated TV-PG or higher, then you could block out all programming TV-PG and above containing adult language.

To block program content:

1. Determine the lowest level of content you do not want the child to watch.
2. Use the left and right arrows to highlight the Rating Field.
3. Use the up and down arrows on the remote to scroll through the age-based ratings until the rating that corresponds with the lowest content you do not want the child to watch appears. (In the example above, you would scroll through the ratings until the TV-PG rating appeared.)
4. Press the right arrow to move the highlight to the field corresponding with the content theme you wish to block out.
5. Press the up or down arrow to change content status from *V* to *B*. All higher ratings' content theme will automatically change to *B*.

Content Themes	
D	Sexually Explicit Dialogue
L	Adult Language
S	Sexual Situations
V	Violence
FV	Fantasy Violence

MENUS AND FEATURES

You must remember to Lock Parental Controls for rating limits to take effect.

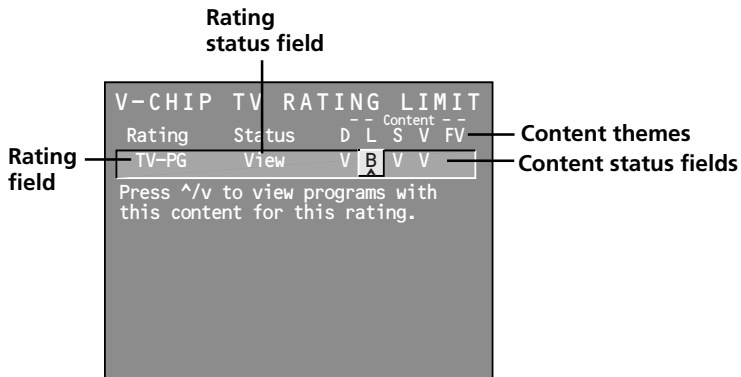

6. Press MENU or OK to return to the menu or exit the screen.

Viewing Specific Content Themes

If you block specific content themes, you have the option of going back and changing some of the content themes back to View (V):

1. Determine the content themes you want to change to View (V).
2. Use the left and right arrows to highlight the Rating Field.
3. Use the up and down arrows to scroll through the age-based ratings until the rating whose content theme you want to change to *View* appears.
4. Press the right arrow to move the yellow highlight to a particular content theme status, such as the *B* under language (L) corresponding with TV-14.
5. Press the up or down arrows to change its status back to *V*. Your child would then be able to watch programs with TV-14 adult language content, but not programs with TV-PG or TV-MA language content.

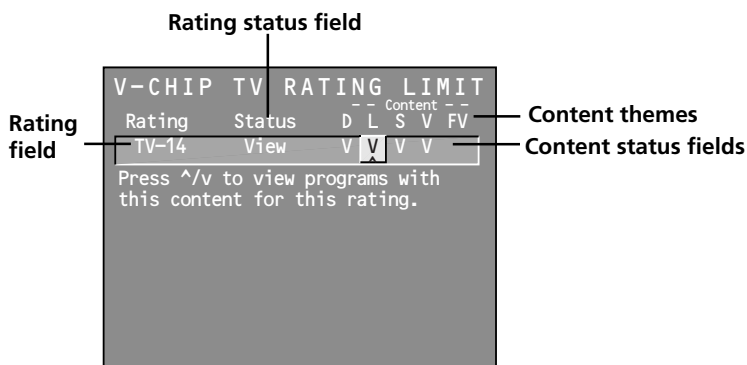

Note that only the content theme status corresponding to TV-14 language (L) changes to View (V). Higher rated content themes, such as that for TV-MA language, do not change.

MENUS AND FEATURES

V-CHIP MOVIE RATING LIMIT

You set movie rating limits by blocking movies rated above a specified level.

Blocking Movie Ratings

If you only want your child to watch movies that have a PG rating and lower (in other words, movies rated PG and G), then you could automatically block out all other movies with higher ratings.

To block movies:

1. Highlight the rating field and press the up and down arrows to find the rating that is the lowest rating you do not want the child to watch. (In the example above, you would point to the rating status button corresponding to PG-13, since the highest rating you want the child to watch is PG.)
2. Use the right arrow to highlight the rating status field. Press OK to change the button from *View* to *Block*.

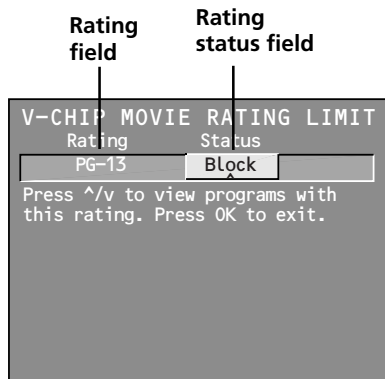

3. Press MENU or OK to return to the menu or exit the screen.
4. If Parental Controls are not locked, you must lock them so the movie rating limits will take effect. See the section *Lock/Unlock Parental Controls*.

Viewing Movie Ratings

After you block movie ratings, you have the option of changing some of the rating status buttons back to View:

1. Highlight the rating field and press the up and down arrows to find the rating you want to view.
2. Use the right arrow to highlight the rating status field. Press the up and down arrows to change the button from *Block* to *View*.

For example, if movies with a rating of PG-13 and higher are blocked, you can change the rating status button corresponding with NC-17. Your child would then be able to watch all movies with a G, PG, and NC-17 rating.

3. Press the left arrow to return to the menu or exit the screen, and be sure parental controls are locked (see the section *Lock/Unlock Parental Controls*).

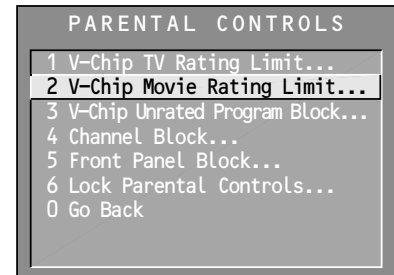

Some movies may be given a Not Rated (NR) rating. After blocking movie ratings, you must set NR to view separately to view NR movies.

You must remember to Lock Parental Controls for ratings limits to take effect.

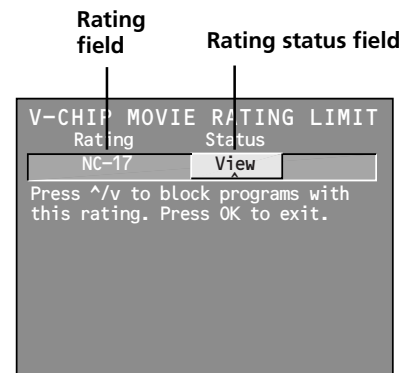

MENUS AND FEATURES

V-CHIP UNRATED PROGRAM BLOCK

Selecting this option lets you decide if programs that the V-Chip recognizes as “unrated” can be viewed. Note that “unrated” TV programs can include news, sports, political, religious, local, and weather programs, emergency bulletins, public announcements, and programs without a rating.

View All unrated programs are available.

Block All unrated programs are not available.

Don't forget to lock parental controls after you change the status of unrated program viewing. If you do not, the limit will not take effect.

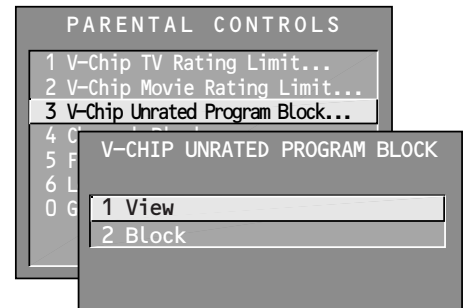

CHANNEL BLOCK

Selecting this option lets you decide what channels can be viewed.

View All channels are available.

Block The front panel CH (channel) buttons will tune only to channels that you have marked as *View*. The remote will still tune to the blocked channel if you use the digits to access the channel.

Don't forget to lock parental controls after you change the status of Channel Block. If you do not, the channel block will not take effect.

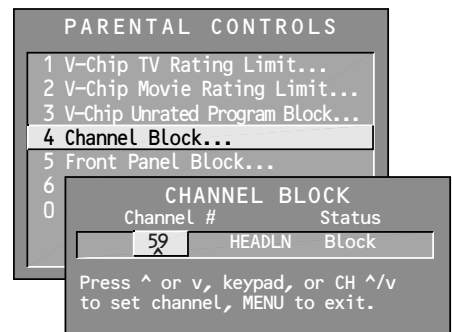

FRONT PANEL BLOCK

Selecting this option lets you block (disable) or unblock (enable) the monitor's front panel. The remote still tunes to any channel. Front Panel Block can:

- Keep children from watching TV when the parent is not present.
- Keep small children from playing with the buttons.

(When using this as a Parental Control method, you should remove access to any remote capable of controlling the monitor while you have the Front Panel blocked.)

Don't forget to lock parental controls after you change the status of Front Panel Block. If you do not, the block will not take effect.

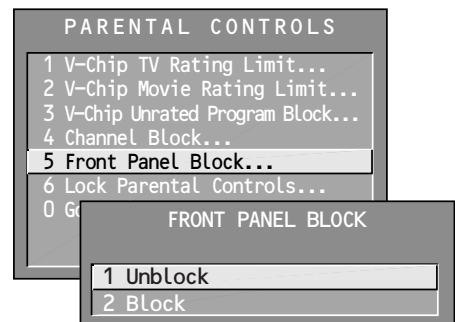

LOCK/UNLOCK PARENTAL CONTROLS

Selecting this option lets you lock and unlock parental controls settings using a password.

If you do not lock parental controls, none of the settings for V-Chip, Channel Block, or Front Panel Block will take effect.

If you forget your password, press and hold TV on the remote and the MENU button on the television simultaneously for 3 seconds. Parental controls will then unlock and you can re-enter a password via *Lock Parental Controls*.

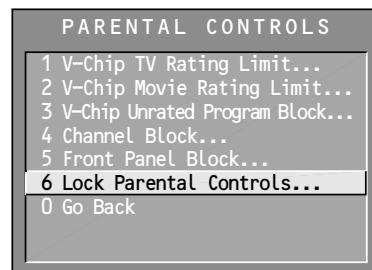

MENUS AND FEATURES

PIP (PICTURE-IN-PICTURE) OPERATION

The PIP (picture-in-picture) feature lets you display a second, smaller picture on top of the main picture. Note that PIP is not available when you are in VGA mode.

PIP BUTTONS

There are four remote buttons that control the way the PIP window works:

PIP Brings up the PIP window. Press PIP again to remove the window.

Move buttons Let you move the PIP window to different areas of the screen.

SWAP Switches, or "swaps," the video from the PIP window with the main picture.

CH CTRL (Channel Control) Lets you switch channel control between the PIP window and the main picture. To determine whether you are controlling the PIP or the main picture, bring up the Channel Marker (detailed on the following page). The yellow channel number is the one you are controlling.

For instance, press PIP to bring up the PIP window. You can change channels by entering digits or pressing the channel up or down. When you press the CH CTRL button, the channel control switches to the main picture. You can now change channels in the main picture by entering digits or pressing channel up or down.

USING THE PIP FEATURE

Skip to PIP: Channel Surfing in the Main Picture

You can surf through the channels during commercial breaks using the SKIP and CH (channel) buttons.

1. Press SKIP to set the commercial skip timer and bring up the PIP window.
2. Press the channel up or down buttons on the remote to surf through the channels in the main picture. When the SKIP feature times out, the main picture will tune to the original channel automatically.

Channel Surfing in the PIP Window

You can use the PIP window to surf through channels as well.

1. Press PIP to bring up the PIP window.
2. Press the channel up or down buttons. The monitor begins displaying each channel in the PIP window. If you see a channel that interests you, press SWAP.

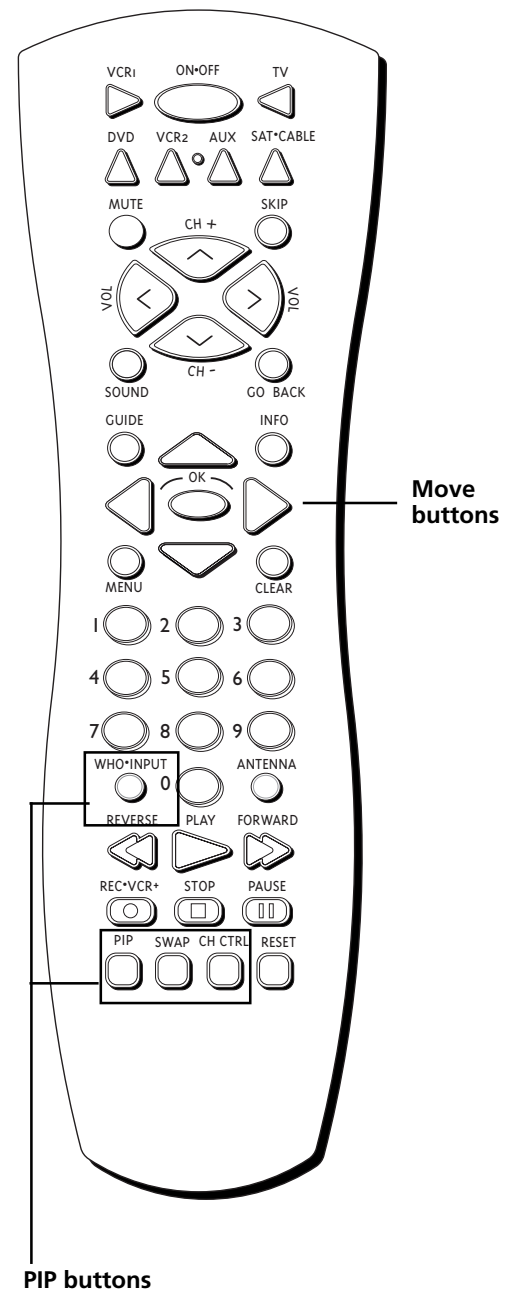

A typical use of SWAP is to scan through channels in the PIP window, and when you find a channel you like, press SWAP to display that channel in the main picture, sending the current channel to the PIP window.

MENUS AND FEATURES

PIP PROBLEMS?

- Make sure the remote is in the right mode. For example, once you turn on the VCR with the VCR1 button, you can't SWAP the pictures until you put the remote in TV mode. Just press the TV button.
- No signal or bad reception? Most VCRs and satellite receivers have an antenna or TV button. If your cable or off-air antenna goes into your VCR or satellite receiver, then into your monitor, try pressing the antenna or TV button on the front of the component.

Tip: If programmed to control your VCR, the ANTENNA button on the remote acts as a TV/VCR button.

- Check the connections. PIP requires a second video source, like a VCR or satellite receiver, connected to your monitor with audio/video cables. If you use a cable box, you may need extra equipment. Contact your cable company for more information.
- PIP is unavailable on the VGA inputs.

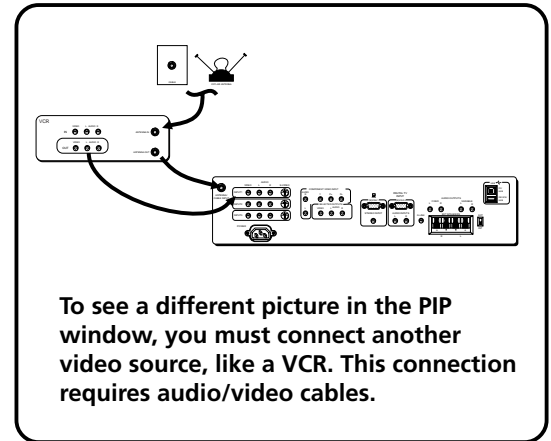

USING THE AUTOTUNING FEATURE

The Autotuning feature automatically tunes the monitor to the correct channel for different components you have connected to your monitor (like a VCR, DVD player, etc.). When you set up Autotuning in the menu system you don't have to remember to change your monitor to channel 3, for example, when you want to watch the tape in your VCR.

How to Set Up the Autotuning Feature

The way you set up the Autotuning feature in the monitor's menu corresponds to the component buttons on the remote and the way you have each component connected to your monitor. When you set Autotuning, you're telling the monitor what channel to tune to when you press the VCR1, VCR2, DVD, or SAT•CABLE button on the remote control.

1. Press MENU.
2. Highlight *Channel* and press OK on your remote control.
3. Highlight *Autotuning* and press OK.

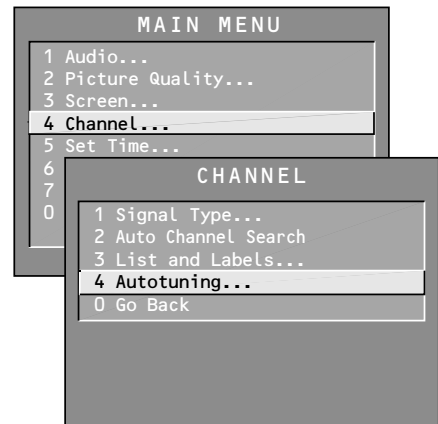

MENUS AND FEATURES

SET THE VCR1 CHANNEL

When you set the VCR1 channel, the monitor automatically tunes to the correct input channel when you press the VCR1 button on the remote. This is called "Autotuning." If you don't have a VCR1 component connected to the monitor, skip this step.

1. From the Set VCR1 Channel menu (at right), point to the choice that matches the way you have your VCR connected to the monitor.
2. Press OK to select it and continue.

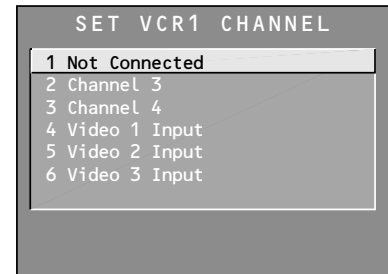

SET THE VCR2 CHANNEL

You can set the VCR2 button on the remote to automatically tune to an input channel as well. If you don't have a VCR2 component connected to the monitor, skip this step.

1. From the Set VCR2 Channel menu (at right), point to the choice that matches the way you have your VCR connected to the monitor.
2. Press OK to select it and continue.

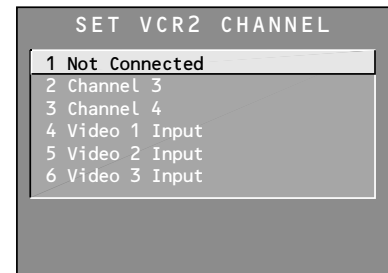

SET THE DVD CHANNEL

When you set the DVD channel, you're telling the monitor what input channel to tune to when you press the DVD button on the remote. Indicate which input you used to connect a DVD player. If you don't have a DVD player connected to the monitor, skip this step.

1. From the Set DVD Channel menu (at right), point to the choice that matches the way you have your DVD connected to the monitor.
2. Press OK to select it and continue.



SET THE SAT/CABLE CHANNEL

When you set the SAT/CABLE channel, you're telling the monitor what channel to tune to when you press the SAT•CABLE button on the remote.

Indicate which input you used to connect a satellite receiver, a cable box or a set top digital converter. If you don't have one of these components connected to the monitor, skip this step.

1. From the Set SAT/CABLE Channel menu (at right), point to the choice that matches the way you have your satellite receiver, cable box, or HD receiver connected to the monitor.
2. Press OK to select it and continue.

MENUS AND FEATURES

CHANNEL BANNER

There are several indicators that come up when you press the TV, INFO, PIP or SWAP button. This display is called the Channel Banner.

12:01 Displays the current time.

CC Displayed when Closed Captioning is available on the current channel.

VCR1 Displays the label assigned to the current channel.

VID1 Displays the current channel or input channel.

Mute (or Stereo) Mute is displayed when you mute the audio. Stereo is displayed when the current channel is broadcasting in Stereo.

SAP Shows the availability of a second audio program.

PIP 59 (PIP Source) Displays the input source, or channel, to which PIP is tuned.

Locked Displayed when parental controls are locked.

00:00 Displayed to count down time left on the commercial skip (SKIP) timer.

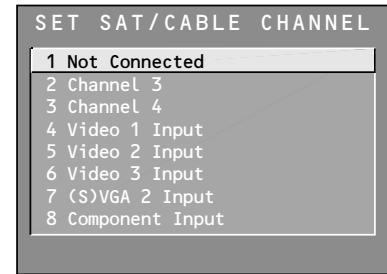

Note that the (S)VGA2 input can be used to connect an HD receiver so you can receive high definition signals.

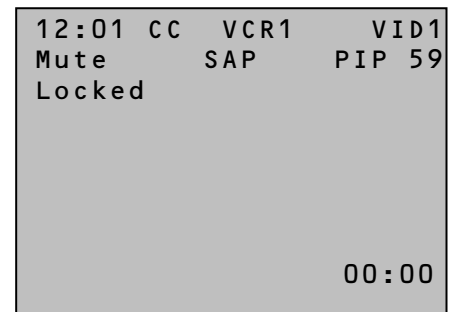

Sample displays on a Channel Banner.

MENUS AND FEATURES

GUIDE PLUS+ GOLD MENU

You can access the GUIDE Plus+ Gold menu directly by pressing GUIDE on the remote, or by pressing MENU on the remote and then selecting *GUIDE Plus Menu*. If you press MENU on the remote, you can access several other features the GUIDE Plus+ Gold System offers:

GUIDE Plus+ Setup Displays the GUIDE Plus+ Gold setup screen.

Setup Setting up the GUIDE Plus+ Gold System is detailed in the *Setting Up* section of this book.

View Demo Runs the GUIDE Plus+ Gold System demonstration.

Options Displays the GUIDE Plus+ Gold autodisplay options.

On Automatically displays the GUIDE Plus+ Gold System when you use the TV button on the remote to turn on the TV.

Off Disables the GUIDE Plus+ Gold System from being displayed when you use the TV button on the remote to turn on the TV.

GUIDE Plus+ Label Displays the GUIDE Plus+ Gold label menu.

On Displays the station name when you change channels.

Off Disables the Label feature.

Continuous Demo Runs the GUIDE Plus+ Gold demonstration until it is turned off. To end the Continuous Demo, press MENU.

The following sections tell you more about the GUIDE Plus+ Gold System, how to use it, and how it works.

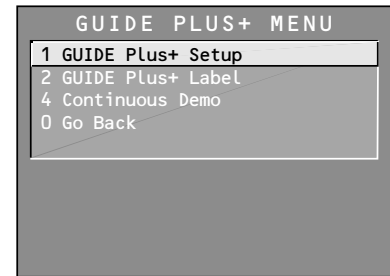

ABOUT THE GUIDE PLUS+ GOLD SYSTEM

The GUIDE Plus+ Gold System is an interactive on-screen program guide that lists TV schedules for your area and allows your monitor direct control of a cable box and VCR. You must first set up the GUIDE Plus+ Gold Menu System in order to view it (see the *Setting Up* section for more details).

To bring up the GUIDE Plus+ Gold screen, press the GUIDE button on the remote.

There are six sections to a GUIDE Plus+ Gold screen:

- A row of Action buttons at the top of the screen numbered 1, 2 and 3
- Program information
- A row of Menu options
- Channel listings
- Advertising and special show information
- Live video window

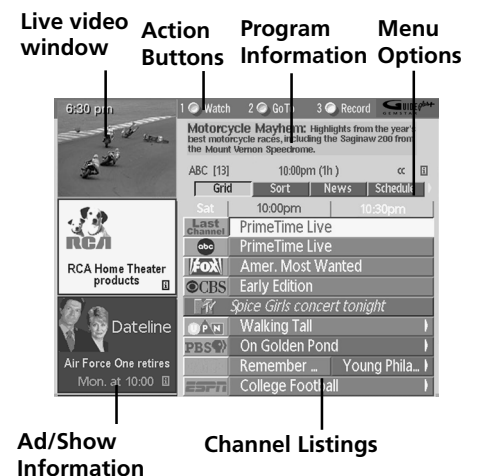

MENUS AND FEATURES

Getting In & Out of the GUIDE Plus+ Gold System

To enter the GUIDE Plus+ Gold System:

- Press GUIDE on the remote.

There are three ways to exit the GUIDE Plus+ Gold System:

- Press OK to exit the GUIDE Plus+ Gold System and tune to the channel highlighted in the Channel listing.
- Press GUIDE to exit the GUIDE Plus+ Gold System and tune to the channel displayed in the View window.
- Press CLEAR to exit the GUIDE Plus+ Gold System and return to the original channel.

DOWNLOADING DATA

The GUIDE Plus+ Gold System is not available until it completes its first download of program information. When the power is turned off, the monitor locates a "host channel" that carries GUIDE Plus+ Gold data containing program schedule and channel mapping information. A channel map is the list of stations and their respective channels.

To ensure that your first download of data is complete, you should leave your monitor off overnight. Downloads occur several times a day. *The monitor must be turned off for GUIDE Plus+ Gold data to download.*

If the monitor loses power or is unplugged, GUIDE Plus+ Gold program information may be lost. When power is restored, make sure the setup information is still correct. The GUIDE Plus+ Gold program will complete a download at the next available time.

Channel Mapping

If more than one cable company services your area, you may be prompted with a Channel Mapping screen after the first GUIDE Plus+ Gold download. You will need to identify your cable company by selecting the correct channel numbers for the stations in question.

- Use the left and right arrows to change the channel group and press OK when the correct channel group is highlighted.

The Different GUIDE Plus+ Gold System Menus

The GUIDE Plus+ Gold System offers seven different options on the Menu bar: GRID, SORT, NEWS, SCHEDULE, MESSAGES, EDITOR and SETUP. To access the Menu bar:

1. Press GUIDE to bring up the GUIDE Plus+ Gold screen.
2. Press MENU or use the up and down arrows to highlight the Menu bar. The Grid Guide comes up by default.
3. Use the left and right arrows to access other menus.
4. Press OK, MENU, or use the down arrow to see the menu options.

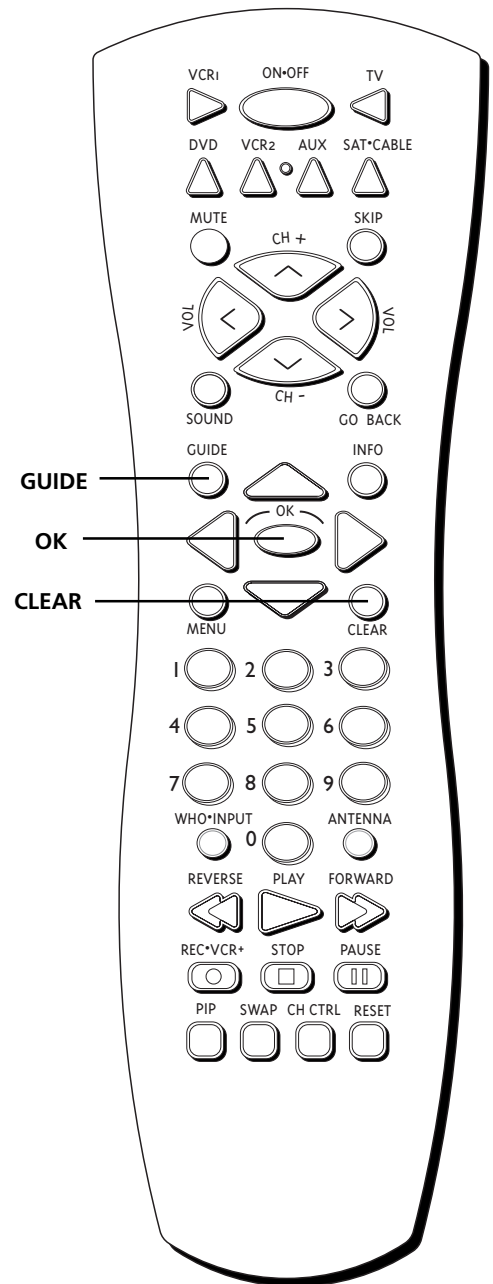

Since the program information provided by the GUIDE Plus+ Gold system is based on your locale, you will need to run Setup again if you move.

MENUS AND FEATURES

GRID GUIDE

The Grid Guide appears each time you enter the GUIDE Plus+ Gold menu System. It displays the current programming for each channel. The live program is displayed in the video window.

- Use the up and down arrows to browse channel listings and CH ^/v to page through listings. Use the right and left arrows to browse future program listings.
- To tune to a channel, highlight the program you want to view in the channel listing and press OK. Press CLEAR to exit the GUIDE Plus+ System and return to the original channel. Press GUIDE to exit the GUIDE Plus+ System and tune to the channel in the view window.

Grid Guide Action Buttons

Action buttons will change according to where you are in the GUIDE Plus+ Gold System. Be sure to look at the action bar before pressing the command numbers.

When highlighting the Channel listings, the following Action buttons are available on the bar:



- **Watch** Press 1 on the remote to place a timer in the Schedule for the TV to turn on and tune to the program highlighted in the Channel listing. When the TV turns on, the GUIDE Plus+ Gold System will automatically appear with the scheduled program highlighted and tuned in the View window.
- **Go To** Press 2 on the remote to bring up the direct dial box and enter the number of the channel you want. This will highlight the channel and current program in the channel listing of the Grid Guide. Press OK to tune to the highlighted channel. If the view window is unlocked, you can press GUIDE to tune to the channel.
- **Record** Press 3 on the remote to place a timer in the Schedule for the VCR to record the program highlighted in the Channel listing. If you have a cable box, changing channels on the TV will not cause the cable box channel to change while recording.

The Program information window will display a confirmation when you have successfully created a timer to watch or record. If you have selected two programs to watch or record which begin at the same time or overlap, you will receive a timer conflict message. The GUIDE Plus+ Gold System will not schedule a conflicting timer, therefore you must choose between the two programs.

When highlighting the Channel names (the left column on the Channel listing), the following Action buttons are available on the bar:



GUIDE Plus+ Gold screens illustrated in this book are representations of what you are likely to see. Not all channels, programs, and GUIDE Plus+ Gold information depicted will be available in your area.

New features and options can be downloaded to the GUIDE Plus+ Gold system, so these too are subject to change.

Grid Guide Action Buttons



Grid Guide Menu Selection

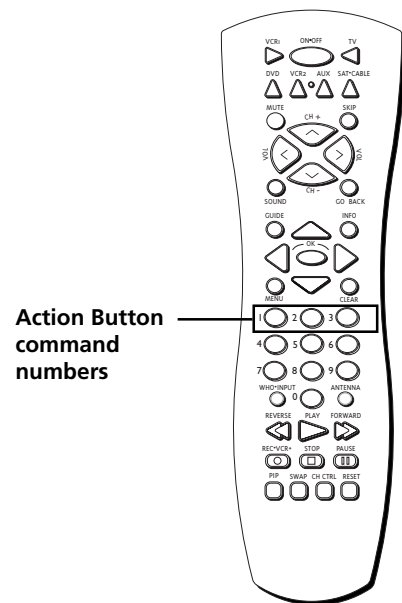

Action Button command numbers

MENUS AND FEATURES

- **Lock/Unlock** Press 1 to lock or unlock the video window to either stay at one channel as you browse the GUIDE Plus+ Gold System (lock) or change as you browse through different channels (unlock). The PIP button on the remote also toggles the video window between the locked and unlocked states.
- **Go To** Press 2 on the remote to bring up the direct dial box and enter the number of the channel you want. This will highlight the channel and current program in the channel listing of the Grid Guide. Press OK to tune to the highlighted channel. If the view window is unlocked, you can press GUIDE to tune to the channel.

SORT

The Sort Menu lets you browse programs by category. The channel to which you are currently tuned is displayed in the video window. To sort:

1. Press MENU on the remote to highlight the Menu bar.
2. Use the arrows to highlight Sort. When Sort is highlighted for the first time, the *Movies* category is displayed. Thereafter, the last category used becomes the default. A listing of subcategories is displayed below the category name.
3. Use the up and down arrows to highlight a subcategory. For example, highlight *All* and press OK.
4. When the listing comes up, *All Movies* are displayed. Use the up and down arrows to browse the list one at a time. Use CH[^] and CH^v to browse through the list one page at a time. You can also view the next seven days' programming by pressing the right arrow.
5. Select MENU to return to the menu bar, or press GUIDE or CLEAR to exit the GUIDE Plus+ Gold System.

Sort Menu Action Buttons

When viewing the results of a Sort, the following Action buttons will appear on the bar:



- **Watch** Press 1 on the remote to place a timer in the Schedule, and then follow the on-line help for further options. Placing a timer in the Schedule will cause the TV to turn on and tune to the program highlighted in the Channel listing at the predetermined time. When the TV turns on, the GUIDE Plus+ Gold System will automatically appear with the scheduled program highlighted and tuned in the View window.
- **Record** Press 3 on the remote to place a timer in the Schedule for the VCR to record the program highlighted in the Channel listing. If you have a cable box, changing channels on the TV will not cause the cable box channel to change while recording.

The program information window will display a confirmation when you have successfully created a timer to watch or record. If you have selected two programs to watch or record which begin at the same time or overlap, you will receive a timer conflict message. The GUIDE Plus+ Gold System will not schedule a conflicting timer; you must choose between the two programs.

The PIP button on the remote also toggles the video window between the locked and unlocked state while the GUIDE Plus+ is displayed.

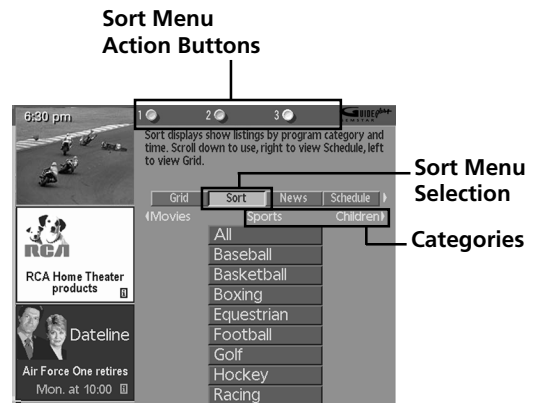

Be sure that during the GUIDE Plus+ Gold setup you specified that you have a VCR. If you do not, the RECORD option will not be available.

MENUS AND FEATURES

NEWS

The News Menu lets you browse current news stories by headline.

1. Press MENU on the remote to highlight the Menu bar.
2. Use the arrows to highlight News.
3. Use the up and down arrows to highlight a story.
 - Use the up and down arrows to browse the list one at a time. Use CH[^] and CH^v to browse through the list one page at a time.
4. Press the right arrow to see full text.
5. Select MENU to return to the menu bar, or press GUIDE or CLEAR to exit the GUIDE Plus+ Gold System.

SCHEDULE

The Schedule menu lets you create timers for either viewing or recording programs. The GUIDE Plus+ Gold System allows one-button recording if you have positioned the G-LINK cable in front of your VCR. See the *Setting Up* section of this manual for more details on positioning the G-LINK cable.

To schedule a program to watch or record:

1. Press GUIDE to bring up the GUIDE Plus+ Gold System.
2. Highlight a program within the Channel listing.
3. Select Watch or Record from the Action buttons bar. The timer is then automatically logged into the Schedule menu.
4. If you select Record, make sure to place a blank tape in the VCR and leave the VCR turned off.

The program information window will display a confirmation when you have successfully created a timer to watch or record.

To remove or change the frequency (daily, once, or weekly) of a scheduled event, access the Schedule Menu from the Menu bar.

1. Press GUIDE to bring up the GUIDE Plus+ System.
2. Press MENU to highlight the Menu bar.
3. Use the arrows to highlight the *Schedule* menu selection.
4. Use the up and down arrows to highlight the program you want to edit. Then use the Schedule Menu Action Buttons as described in the next section.

Schedule Menu Action Buttons

When viewing the Schedule menu the following Action buttons will appear on the bar:



- **Remove** Highlight the Watch or Record timer you wish to remove from the schedule and press 1 on the remote.
- **Change** Highlight the Watch or Record timer you wish to change and press 3 on the remote to toggle the frequency between the following choices:

DAILY records the same program each day Monday through Friday.

ONCE records only on that day.

WEEKLY records the program each week at the same time.



News Menu Selection



Sample News Story

Schedule Menu Action Buttons



Schedule Menu Selection

MENUS AND FEATURES

MESSAGES

Occasionally you will receive messages regarding your GUIDE Plus+ Gold System, as well as special programming information. You can access these messages from the Message Menu on the Menu bar.

To read messages:

1. Press MENU on the remote to select the Menu bar.
2. Use the arrows to highlight the Messages menu selection.
3. Highlight the message you wish to read by using the up and down arrows.
4. Press INFO to display the full text of the message. If the text continues beyond the screen, press INFO to view the next page of text. Once you have reached the end of the message, pressing INFO closes the expanded information and returns you to the Messages screen.
5. Then use the Messages Menu Action Button as described in the next section.

Messages Menu Action Button

When viewing the Messages menu the following Action button will appear on the bar:



- **Remove** Highlight the message you wish to delete and press 1 on the remote.

EDITOR

You may customize the channel listing by enabling or disabling the display of certain channels. For instance, you may disable channels that you never watch. You can restore disabled channels at a later point in time.

1. Press GUIDE to bring up the GUIDE Plus+ system.
2. Press MENU to highlight the Menu bar.
3. Use the right and left arrows to highlight the *Editor* menu selection.
4. Use the up and down arrows to select a channel.

Then use the Editor Menu Action Buttons as described in the next section.

If you have selected two programs to watch or record which begin at the same time or overlap, you will receive a time conflict message. The GUIDE Plus+ Gold system will not schedule a conflicting timer, therefore you must choose between the two programs.

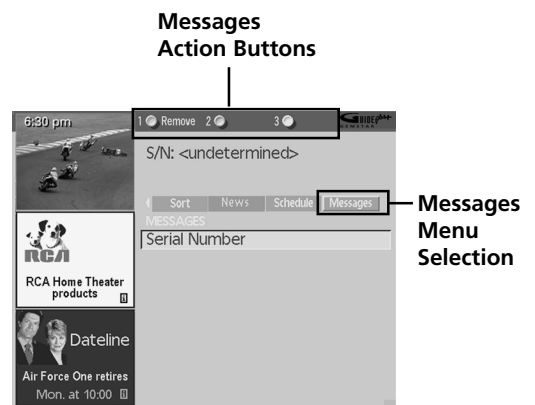

MENUS AND FEATURES

Editor Menu Action Buttons

While browsing the Editor menu, the following Action buttons are available on the bar:



- **Cancel** Press 1 on the remote to cancel any changes made since entering the Editor Menu.
- **Change** Press 2 on the remote to change the channel number for the highlighted channel line.
- **On/Off** Press 3 on the remote to toggle the state of the channel between On and Off.

Editor Menu Action Buttons



Editor Menu Selection

SETUP

The Setup Menu lets you access GUIDE Plus+ System setup information. To access the Setup option:

1. Press MENU on the remote to highlight the Menu bar.
2. Use the arrows to highlight the Setup menu option.
3. Use the up and down arrows to select Setup, View Demo, or Options:
 - **Setup** Displays the GUIDE Plus Gold System setup screens. Setting up the GUIDE Plus+ Gold System is detailed in the *Setting Up* section of this book.
 - **View Demo** Runs the GUIDE Plus+ Gold System demonstration.
 - **Options** Displays the GUIDE Plus+ Gold autodisplay options.
 - On** Automatically displays the GUIDE Plus+ Gold System when you use the TV button on the remote to turn on the TV.
 - Off** Disables the GUIDE Plus+ Gold System from being displayed when you use the TV button on the remote to turn on the TV.

EXPANDED INFORMATION

To view more information about a program, advertisement or special, highlight the channel listing or ad/show information box and press the INFO button. Requesting more information about a particular show will also display the PlusCode programming number and the Shows on Next for that channel.

Pressing INFO while highlighting an ad panel will fill the screen with any additional and/or promotional information regarding that particular program.

Pressing the INFO button again exits the expanded information screen.



Ad/Show Information

Troubleshooting

Troubles sometimes are caused by simple "faults" that you can correct without a service technician. Here are a few basic remedies:

Program information does not download

- Review your setup information and make sure it is correct.
- The monitor must be off to download information. Leave your monitor off overnight, for at least 10 hours, to receive a download for your area.
- If you are using a cable box, make sure the cable box is on in order to receive program information.
- If you are using a VCR, make sure the VCR is off in order to receive program information.

Scheduled Watch or Record does not occur

- Check Schedule for timer conflicts.
- Check that G-LINK cable wand is positioned correctly.
- Make sure there is a tape in the VCR and that the G-LINK wand is properly positioned and the VCR is off.

REFERENCE

GOOD INFORMATION TO KNOW

This section contains information that you don't have to know to use your monitor, but may want to refer to from time to time. It includes a specification sheet, a troubleshooting section, the limited warranty, an accessories order form and an index.

1 MAKING CONNECTIONS



2 SETTING UP



3 USING THE REMOTE



4 MENUS AND FEATURES



5 REFERENCE

REFERENCE

RCA MULTIMEDIA MONITOR SPECIFICATIONS*

PICTURE	Optimum Contrast Screen	Yes		
	Picture Power (Watts)	44.8		
	Stripe Pitch52mm at center		
	Dynamic Focus	Yes		
	Scan Velocity Modulation	Yes		
	Aperture Sharpness	Yes		
	Comb Filter	Frame Comb (3D Y/C)		
	Auto Color Control	Color Level & Tint		
	Black Stretch	Yes		
	Color Detail Enhancement	Yes		
	Wide Band Video Amplifier	Yes		
	Video Noise Reduction	Yes		
	Calibrated Color Temperature	6500, 7500 & 9300 kelvin		
	MULTI-SYNC SCAN MODES	NTSC	15.734Khz/ 60 Hz Interlaced	
		VGA	640x480, 60 Hz Progressive	
SVGA		800x600, 60Hz Progressive		
HDTV		1280x1080 Interlaced		
SOUND	Audio Power (Watts) Total	20 (10 Watts/Ch)		
	DBX† Broadcast Stereo	Yes		
	Second Audio Program	Yes		
	SRS / Sound Retrieval System	Focus		
	Speakers	2 - 5"X 7" High Compliance plus two 2" Tweeters		
CONVENIENCE	Channel Tuning Capability	181		
	Dual tuner Picture-in-Picture	Yes		
	PIP, Swap, and Move	Yes		
	Channel Labeling	Yes		
	Parental Control	Yes		
	Stereo Headphone Jack	3.5mm Stereo Mini-jack		
	Front A/V Input	Composite, L (Mono)/ Right		
	Plug & Play Compatibility	VESA DDC2B (VGA1)		
	Front Universal Serial Bus	2 - Hub		
BACK PANEL INPUTS/OUTPUTS	Universal Serial Bus	Hub & Host		
	A/V Inputs	3 - S-Video / Composite		
	Component Video Input	Y-Pr-Pb (RCA Jacks) Synchronscan		
	Monitor Control	VESA DDC2B (VGA 1)		
	UHF/ VHF, Cable Input	75-ohm Terminal		
	VGA & SVGA Inputs	2 - 15 Pin D-sub		
	Selected A / V Outputs	Composite, L / R		
	Computer Audio Input Jack	3.5mm Stereo Mini-jack (VGA1)		
	Audio Output Jacks	Fixed And Variable		
	External Speaker Terminals	Yes		
G-LINK jack	Yes			
GENERAL SPECIFICATIONS		MM52110	MM61110	
	Screen Size (Measured Diagonally)	52"	61"	
	Dimensions (H X W X D)	52 X 44.25 X 24.5"	61 X 51.5 X 25.25"	

* Specifications are subject to change.

† DBX is a registered trademark of Carillon Electronics Corporation.

REFERENCE

TROUBLESHOOTING

Troubles sometimes are caused by simple “faults” that you can correct without the help of a service technician. If you experience any difficulty with your monitor, check a few basic remedies before calling your service technician.

Monitor will not turn on

- Check to make sure it is plugged in.
- Check the wall receptacle (or extension cord) to make sure it is “live” by plugging in something else.
- Maybe batteries in remote control are “dead.”
- Maybe remote control is not aimed at remote sensor.
- The front panel controls may be locked (disabled). Use the remote control to unlock the front panel controls by selecting the *Front Panel Block* in the Parental Controls menu and choosing *Unlock*.

Controls don't work

- If using remote control, make sure remote is in TV mode by first pressing TV button.
- The front panel MENU button may be disabled. Use the remote control to turn off channel blocking. Select *Channel Block* in the Parental Controls menu and choose *Off*.
- Try unplugging monitor for two minutes and then plug it back in and turn it on again.

Problems with remote

- Maybe something is between the remote and the remote sensor.
- Maybe the remote is not aimed directly at the component (monitor, DVD player, VCR, etc.) you are trying to control.
- Maybe the remote is not in TV mode. Press the TV button so the remote will control the monitor.
- Maybe the batteries in the remote are weak, dead or installed incorrectly. Try replacing the batteries. (Note, if you remove the batteries, you may have reprogram the remote to control other components.)
- Remove the batteries and hold the number 1 for at least 60 seconds to drain the microprocessor inside the remote. Release the number 1, replace the batteries, and (if necessary) reprogram the remote.

Blank screen

- Maybe the component connected to the input jacks is not turned on.
- Try another channel.
- If you have connected a digital set top converter, you must connect to both the (S)VGA2 and INPUT2 inputs in order to view both digital and analog signals.
- Due to copyright restrictions, you may not be able to view some high definition programs in high definition format using this product. To view this type of programming in standard definition format, you must also connect the Audio/Video jacks from the HD receiver to the monitor.
- Monitor may be in powersave, or standby, mode. Press the TV or ON•OFF on your remote, or the POWER button on the front panel.

Picture on screen is not centered while in VGA mode

- Adjust picture by going to Picture Position in the Screen Menu. Use remote arrows to adjust the horizontal and vertical position of the main picture window.
- Display properties may not be set correctly. Consult your computer operating system's owner's manual on how to adjust the display properties.

REFERENCE

Horizontal or diagonal lines on screen

- In some cases, the computer and monitor may not be synchronized properly. To set the correct resolution for your monitor you should consult your operating system's owner's manual on how to "boot" your system up into the "safe mode" and set monitor display for the desired mode (such as SVGA 800x600 Progressive).

Black box appears on the screen

- Captioning may be turned on and in text mode. Check the Closed-Caption Display control panel in the Channel menu.

No sound, picture okay

- Maybe the sound is muted. Try pressing the volume up button to restore sound.
- Maybe the speakers are turned off. Check the Audio Output and Speakers control panel in the Audio menu.
- If using an S-VHS component, remember to also connect the component's L and R AUDIO OUT jacks to the TV's L and R INPUT jacks.
- Check the INT/EXT switch on the back of the monitor.

Can't select certain channel

- Channel may be blocked or not approved in the Parental Controls menu.
- If using a VCR, check to make sure the TV/VCR switch on the VCR is in the correct position.

Turns off while playing

- Electronic protection circuit may have been activated because of a power surge. Wait 30 seconds and then turn on again. If this happens frequently, the voltage in your house may be abnormally high or low.
- Maybe sleep timer is set.
- Unplug. Wait five minutes. Plug in again.

Noisy stereo reception

- May be a weak station. Use Audio menu to choose *mono* sound.

No picture, no sound but TV is on

- Maybe the cable/air function is set to the wrong position.
- Maybe a vacant channel is tuned.
- If watching a VCR (connected only through antenna input), make sure your TV is tuned to channel 3 or 4—the same as the CH3/4 switch on your VCR. Also check to make sure the TV/VCR switch on your VCR is in the correct position.

REFERENCE

GUIDE Plus+ G-LINK cable not working

- Check to make sure the cable wand is positioned correctly in front of the IR sensors on the VCR and/or cable box.
- GUIDE Plus+ system control of cable box is slower than direct control of the box itself. Keep this in mind when changing channels.

Guide comes on when I turn on TV

- The GUIDE Plus+ system automatically comes up when you use the TV button on the remote to turn on the TV. You can turn off this feature by selecting *Setup* from the *GUIDE Plus+ Menu*, selecting *Options*, then setting *Auto Display* to *Off*.

Sound okay, picture poor

- Check antenna connections.
- Try adjusting sharpness function to improve weak signals.

CARE AND CLEANING

CAUTION: Turn OFF your monitor before cleaning.

You can clean the monitor as required, using a soft lint-free cloth. Be sure to occasionally dust the ventilation slots in the cabinet to help assure adequate ventilation.

The monitor's screen may be cleaned with a soft, lint-free cloth as well. Take care not to scratch or mar the screen. If necessary, you may use a cloth dampened with warm water.

Never use strong cleaning agents, such as ammonia-based cleaners, or abrasive powder. These types of cleaners will damage the monitor.

While cleaning do not spray liquid directly on the screen, or allow liquid to run down the screen and inside the monitor. Also, avoid placing drinks or vases with water on top of the monitor. This could increase the risk of fire or shock hazard or damage to the monitor.

Caution: If fixed (non-moving) images are left on the screen for long periods, they may be permanently imprinted on the screen. Such images include network logos, phone numbers, and video games. This damage is not covered by your warranty. Extended viewing of channels displaying these images should be avoided.

REFERENCE

RADIO INTERFERENCE

This equipment has been type tested and found to comply with the limits for a Class B Digital Device in accordance with the specifications in Part 15 of FCC Rules. These rules are designed to provide reasonable protection against radio and television interference in a residential installation. This equipment generates, uses and can radiate radio frequency energy and, if not installed and used in accordance with the instructions, may cause harmful interference to radio communications. However, there is no guarantee that interference will not occur in a particular installation.

If this equipment does cause interference to radio or television reception (which you can determine by turning the equipment off and on), try to correct the interference by one or more of the following measures:

- Reorient or relocate the receiving antenna (that is, the antenna for radio or television that is "receiving" the interference).
- Change the position of the multimedia monitor with respect to the radio or television equipment that is receiving interference.
- Move the multimedia monitor away from equipment receiving interference.
- Plug the multimedia monitor into a different wall outlet so the receiver and equipment receiving interference are on different branch circuits.

If these measures do not eliminate interference, please consult your dealer or an experienced radio/television technician for additional suggestions. Also, the Federal Communications Commission has prepared a helpful booklet, "How To Identify and Resolve Radio/TV Interference Problems". This booklet is available from the U.S. Government Printing Office, Washington, D.C. 20402. Please specify stock number 004-000-00345-4 when ordering copies.

REFERENCE

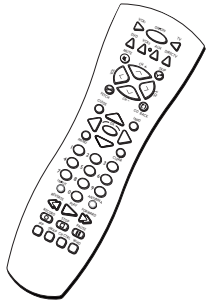

CRK76TA1

Remote Control This is the remote control that came packed with your TV. Replacements or spares can be ordered as needed.

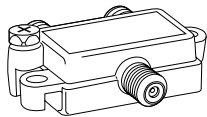

Splitter
VH47

2-way Signal Splitter helps you connect to a second TV or VCR.



ANT200

Amplified VHF/UHF/FM Antenna allows you to easily switch from the antenna signal to cable or satellite easily without disconnecting antenna.

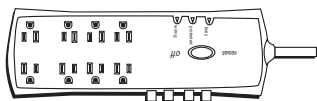

SCTV 160

Surge Protector provides eight outlets, coaxial and telephone line protection. Audible alarm for surge failure.

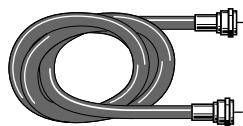

VH81 (3-ft)
VH82 (6-ft)

Screw-on Cable attaches to the round antenna connectors (called 75-ohm F-type) on the back of your VCR or TV. The ends screw onto the connectors for a secure connection.



VH83

Standard Audio/Video cable with RCA-type phono plugs.



VH913

S-Video Cable has multi-pin connectors on each end for connecting S-Video components to your TV.



Detach Here

Accessory Order Form

Description	Part No.	Price	Qty	Total
Screw-on antenna cable (3-ft)	VH81	\$3.95		
Screw-on antenna cable (6-ft)	VH82	\$5.95		
Push-on antenna cable (6-ft)	VH89	\$5.95		
Monaural VCR Dubbing Cable (6-ft)	VH83	\$5.95		
Stereo VCR Dubbing Cable (6-ft)	VH84	\$9.95		
S-Video Cable (6-ft)	VH976	\$7.95		
S-Video Cable (12-ft)	VH913	\$14.95		
2-way Signal Splitter	VH47	\$3.95		
Amplified Antenna	ANT200	\$49.95		
Remote Control (CRK76TA1)	240895	\$29.20		
Audio•Video Adapter	228449	\$4.45		
Surge Protector	SCTV160	\$49.95		

Prices are subject to change without notice.

Total Merchandise \$

Sales Tax \$

We are required by law to collect the appropriate sales tax for each individual state, country, and locality to which the merchandise is being sent.

Shipping and Handling \$ 5.00

Total Amount Enclosed \$

Use VISA, MasterCard, or Discover Card preferably.

Money order or check must be in U.S. currency only.

No COD or CASH.

All accessories are subject to availability. Where applicable, we will ship a superseding model.

Please complete other side also

REFERENCE

Charge your order on your VISA, MasterCard, or Discover Card by filling in below

USE YOUR CREDIT CARD

IMPORTANT: Copy complete account number from your VISA card



My card expires:

IMPORTANT: Copy complete account number from your MasterCard



Copy Number above your name on MasterCard My card expires:

IMPORTANT: Copy complete account number from your Discover Card



My card expires:

AUTHORIZED SIGNATURE
 (Credit card order will not be processed without signature)

Print or type your name and address clearly.



A complete and correct order will save you days of waiting.

Name: _____
 Street: _____
 _____ Apt: _____
 City: _____
 State: _____ Zip: _____
 Daytime phone number: _____

Please make sure that both sides of this form have been filled out completely.

- Allow 4 weeks for delivery.
- All accessories are subject to availability.
- Prices are subject to change.

Placing an Order

To place your order by phone, have your Visa, MasterCard or Discover Card ready and call the toll-free number listed below.

Use this number only to place on order for accessory items listed on this order form.

1-800-338-0376

To place your order by mail, detach and mail the completed order form with credit card information, money order or check in US currency (made payable to Thomson Consumer Electronics, Inc.) to the following address:

Video Accessories
PO Box 8419
Ronks, PA 17573

REFERENCE

RCA PROJECTION MULTIMEDIA MONITOR LIMITED WARRANTY

What your warranty covers:

- Any defect in materials or workmanship.

For how long after your purchase:

- One year for labor charges.
- One year for parts.
- Two years for the picture tube.

The warranty period for rental units begins with the first rental or 45 days from date of shipment to the rental firm, whichever comes first.

What we will do:

- Pay any Authorized RCA Digital Television Service Center the labor charges to repair your monitor.
- Pay any Authorized RCA Digital Television Service Center for the new or, at our option, refurbished replacement parts and picture tube required to repair your television.

How you get service:

- Call 1-888-901-HDTV and have your unit's date of purchase and model number ready.
- A representative will troubleshoot your problem over the phone.
- If the representative determines that you should receive service they will provide you with name(s) of the closest Authorized RCA Digital Television Service Center(s).
- Contact the Service Center and arrange for home service.
- Show the Authorized Service Center Representative your sales receipt or other evidence of purchase date or first rental.

What your warranty *does not* cover:

- Customer instruction. (Your Owner's Manual clearly describes how to install, adjust, and operate your monitor. Any additional information should be obtained from your dealer.)
- Installation and related adjustments.
- Signal reception problems not caused by your monitor.
- Damage from misuse or neglect.
- Batteries.
- Images burned onto the screen.
- A monitor that has been modified or incorporated into other products or has been used for institutional or other commercial purposes.
- A monitor purchased or serviced outside the U.S.A.
- Acts of God, such as but not limited to lightning damage.

Product registration:

- Please complete and mail the Product Registration Card packed with your monitor. It will make it easier to contact you should it ever be necessary. The return of the card is not required for warranty coverage.

How state law relates to this warranty:

- This warranty gives you specific legal rights, and you also may have other rights that vary from state to state.

If you purchased your television outside the United States:

- This warranty does not apply. Contact your dealer for warranty information.

Service calls that do not involve defective materials or workmanship are not covered by this warranty. Costs of such service calls are the sole responsibility of the purchaser.

REFERENCE

A

Adjust Projection TV 26

ANTENNA Button 19

Antenna/Cable In Jack 4

Audio

Output 7

Processor 24

Remote Codes 22

Audio Menu 24

Audio Processor 24

Mute 24

Sound Logic Stereo 24

Speakers 24

Tone Controls 24

Mono 24

Second Audio Program 24

SRS Stereo 24

Stereo 24

Audio/Video Inputs 5

Auto

Channel Search 27

Color 25

Converge 26

Tuning 38

Tuning the SAT/Cable Channel 28, 38

Tuning the VCR1 Channel 28, 38

Tuning the VCR2 Channel 28, 38

Automatic Code Search 20

Automatic Convergence 26

AUX Button 18

AV Receiver 11

B

Back Panel

AV Inputs 5

Batteries 18

Black Level 24

Blue Convergence 26

Buttons

Front Panel 21

Remote 18

C

Care and Cleaning 53

CC 39

CH CTRL 19, 37

Chan

Labels 27

Channel

Banner 38

Block 36

Mapping 41

CLEAR Button 19

Closed Caption

Display 25

Mode 26

Coaxial Cable 4

Color Warmth 25

Computer/Text Mode 12, 25

Connecting Components 4

Computer 13

HD Receiver 14

Connecting Optional Components

AV Receiver 11

DVD Player 10

Satellite Receiver 9

Speakers 11

VCR 8

Content Themes 30

Contrast 24

Convergence 26

Current Channel 39

D

DDC2B 13

Demo Pin 15

DVD

Button 18

Player 29, 39

E

Editor

GUIDE Plus+ System 47

EXT/INT Switch 7

External Speakers 7

F

Finding the Sensor 15

Fixed Images 53

Fixed Output 7, 11

Front Panel

Block 36

Buttons 21

Inputs 16

G

G-LINK

Cable 15

GO BACK Button 18

Green Image 26

GUIDE Button 18

GUIDE Plus+ System 40

Advertisements 48

Downloading information 41

Editor 47

Messages 46

News 45

Schedule 45

Sorting menus 44

Troubleshooting 48

I

INFO Button 18

Input

1-3 28, 39

Button on remote 19

Channels 8

INT Switch 7

J

Joysticks 15

K

Keyboards 15

L

Labels 27

LED Light 18

Limited Warranty 57

M

MENU Button 19

Messages 46

GUIDE Plus+ System 46

Modes of Operation 21

Mono 24

Mouse 15

Mute 18, 24, 25, 39

REFERENCE

N

News

GUIDE Plus+ System 45

O

OK Button 18

ON•OFF Button 18

P

Parental Controls

Channel Block 36

Front Panel Block 36

Locking, Unlocking 36

Menu 30

Picture

Mode Settings 12, 25

Position 26

Presets 25

Quality Menu 24

Black Level 24

Color 24

Contrast 24

Sharpness 24

Tint 24

Size 26

Tilt 26

Picture Mode 25

PIP (Picture in Picture)

Buttons 37

PIP Chan 39

PIP Button 19, 37

Point and Select 18

POWER on Front Panel 21

Programming the Remote

Automatic Code Search 20

Testing the remote 20

Protection Against Power Surges 4

R

Radio Interference 54

Rating Limits

Movie 35

TV 31

RCA Cable 5

Red Convergence 26

Remote Control

Buttons 18

Installing the Batteries 18

Programming 20

Remote Control Sensor 15

S

S-Video 5

Cable 5

Input 5

SAT/Cable Channel 28, 38

Satellite Receiver Remote Codes 22

Scan Rates 12

Schedule

GUIDE Plus+ System 45, 46

Screen Menu 25

Second Audio Program (SAP) 24

Select and Point 18

Selected Video Outputs

AUDIO L and R 6

Set

SAT/CABLE Channel 28, 38

Time 29

VCR1 Channel 28, 38

VCR2 Channel 28, 38

Sharpness 24

Signal Type

Cable TV 27

UHF/VHF Antenna 27

SKIP Button 18

SKIP Timer 39

Sort

GUIDE Plus+ 44

Speakers 11

Specifications 50

SRS Stereo Focus 24

Stereo 24, 39

SVGA 12, 13, 29, 39

SWAP Button 19, 37

T

Time

Current 39

Setting 29

Tint 24

Tone Controls 24

Trackball 15

Troubleshooting 51

GUIDE Plus+ System 48

TV Button 18

U

UHF/VHF Antenna 27

USB Inputs/Output 15

V

V-Chip 30

Age-Based Ratings 30

Blocking Movies 35

Content Themes 30

Variable Output 7, 11

VCR Input Channel 8

VCR Remote Codes 22

VCR1 Button 18

VCR1 Channel 28, 38

VCR2 Button 18

VCR2 Channel 28, 38

VESA DPMS 13

VGA 12, 25

Video Inputs

Viewing 5, 6

Video Mode 12, 25

Video Noise Reduction 25

Viewing Video Inputs 5, 6

W

Warranty 57

Y

Y-adapter 5, 13

Please do not send any products to the Indianapolis address listed in this manual or on the carton. This will only add delays in service for your product.

 **THOMSON CONSUMER ELECTRONICS**
10330 North Meridian Street
Indianapolis, IN 46290

©2000 Thomson Consumer Electronics, Inc.
Trademark(s)® Registered
Marca(s) Registrada(s)
Printed in USA
TOCOM 1564412A